

**Customer Contact Details**

| | |
|----------------------------------|--|
| Customer Name: _____ | Ship to Customer Address: <input type="checkbox"/> |
| Advisor: _____ | Shipping Name: _____ |
| Address: _____ _____ _____ | Shipping Address: _____ _____ _____ |
| Phone: _____ | Phone: _____ |
| Email: _____ | Email: _____ |

Additional Information

| | |
|--------------------------------|----------------------------|
| Notes: _____ _____ _____ | Current Wheelchair: _____ |
| | Customer Weight: _____ |
| | Customer Height: _____ |
| | Customer Disability: _____ |

Other

| | |
|---|--|
| VAT Exemption Declaration (UK Only): I declare that I am chronically sick or disabled by reason of: _____ and that I am receiving from RGK Wheelchairs Ltd, the wheelchair specified herein and I claim relief from Value Added Tax under group 12 of schedule 8 to Value Added Tax Act 1994. Signature: _____ Date: _____ | RGK Contact Authorisation: From time to time, RGK would like to send you exclusive information, news and offers on everything RGK, by email or post. We will not pass any of your details to any third party. I would like to be contacted by RGK: <input type="checkbox"/> Signature: _____ Date: _____ |
|---|--|

Guide:

- Base product
- Required option
- Optional Extra
- Critical Information
- Information Needed

PRODUCT STYLE

FXTXZ010 OCTANE FX

XA070 Open design

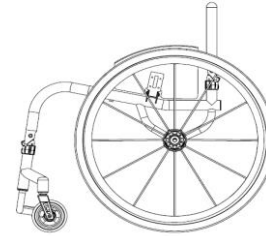

Max User Weight 110kg (242lbs)

PLEASE NOTE: ALL RGK CHAIRS ARE HAND BUILT AND HAVE A MANUFACTURING MEASUREMENT TOLERANCE OF +/- 5MM

CAD APPROVAL

XW009 QUOTE ONLY (NO CAD FOR APPROVAL)

XW011 ORDER (NO CAD FOR APPROVAL)

XW012 QUOTE CAD drawing for approval
(2 customer amendments ONLY)

XW010 ORDER CAD drawing for approval
(2 customer amendments ONLY)

KEY MEASUREMENTS

XY010 Seat width (Inside of sideguards)

mm (Max - 460mm)
(Min - 250mm)

XY020 Seat length

mm (Max - 460mm)
(Min - 250mm)

XY030 Extra seat length (Provides additional leg support & hand grip)

mm

XY050 Front frame height

mm (Max - 550mm)
(Min - 480mm)

XY060 Rear frame height

mm (Max - 550mm)
(Min - 360mm)

XY070 Frame length

mm (Max 625mm)
(Min XY020 + XY030 + 140mm)

XY072 Castor position

mm

Optimise measurements

XA020 Ergonomic seat

Specify length mm (Standard = 120mm)

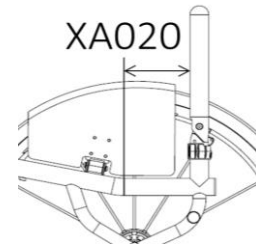
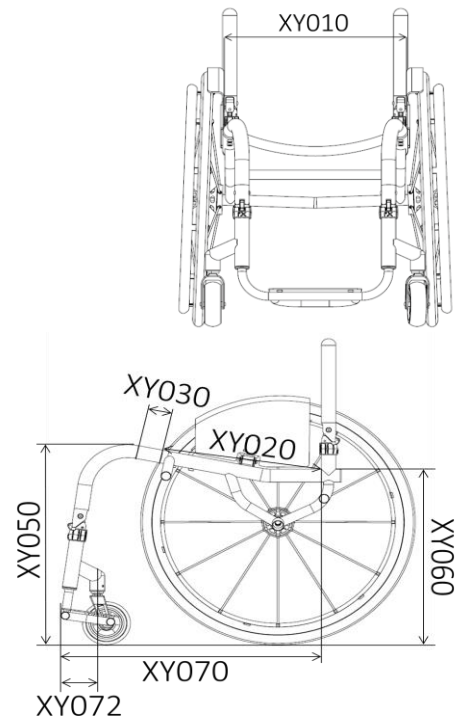

FRONT FRAME AND FOOTREST

Front Frame Options

XY080 Seat taper design

Specify width

!

mm

Optimise measurements
(XY010 Seat Width -100mm)

Footrest Design (Choose One)

XY100 Round design

| Castor Size | Max Height | With XB200 |
|-------------|------------|------------|
| 3" | 115mm | 165mm |
| 4" | 125mm | 175mm |
| 5" | 135mm | 185mm |

XB200 High level footrest *(Only with XB010, XB080 & XB150)*

XY105 Square design

| Castor Size | Max Height | With XB200 |
|-------------|------------|------------|
| 3" | 135mm | 185mm |
| 4" | 145mm | 195mm |
| 5" | 155mm | 205mm |

XB200 High level footrest *(Only with XB010, XB080 & XB150)*

Footrest Individual Measurements

XY115 Front footrest height

!

mm

XY120 Rear footrest height

i

mm
(Std = 20 lower than front height)

XY125 Footrest length

i

mm
(Std = 100mm)
(160mm and over requires heavy duty upgrade XB150)

Footrest Style and Cover

FXTXB080 Tubular footrest welded w/ Aluminium plate
(Supplied with spacer for +20mm adjustment)

FXTXB110 Tubular footrest welded w/ Carbon Fibre plate
(Supplied with spacer for +20mm adjustment)

FXTXB120 Clamp-on aluminium plate footrest
(Angle/height adjustable)





Footrest Options

| CASTOR WHEELS, FORKS & WHEEL LOCKS | |
|---|--|
| Castor Wheels 100mm (4") | |
| <input type="checkbox"/> XC060 | Soft roll 4"x1.3" <i>(Black only)</i> |
| <input type="checkbox"/> XC110 | Aluminium centre 4"x1" <i>(Silver hub and black urethane tyre only)</i> |
| <input type="checkbox"/> XC130 | Aluminium centre 4"x1.4" <i>(Silver hub and black urethane tyre only)</i> |
| <div style="display: flex; justify-content: space-between; align-items: flex-start;"> <div style="width: 30%;"> <p>i <input type="checkbox"/> Silver hub & black tyre</p> <p><input type="checkbox"/> Black hub & black tyre</p> <p><input type="checkbox"/> Red hub & black tyre</p> </div> <div style="width: 30%;"> <p><input type="checkbox"/> Gold hub & black tyre</p> <p><input type="checkbox"/> Green hub & black tyre</p> <p><input type="checkbox"/> Blue hub & black tyre</p> </div> <div style="width: 30%;"> <p><input type="checkbox"/> Purple hub & black tyre</p> </div> </div> | |
| 125mm (5") | |
| <input type="checkbox"/> XC070 | Soft roll 5"x1.3" <i>(Black only)</i> |
| <input type="checkbox"/> XC100 | Pneumatic Aluminium centre 5"x1" <i>(Grey only)</i> |
| <input type="checkbox"/> XC120 | Aluminium centre 5"x1" <i>(Silver hub and black urethane tyre only)</i> |
| <input type="checkbox"/> XC140 | Aluminium centre 5"x1.4" <i>(Silver hub and black urethane tyre only)</i> |
| 150mm (6") | |
| <input type="checkbox"/> XC080 | Soft roll 6"x1.3" <i>(Black hub / grey tyre only)</i> |
| <input type="checkbox"/> XC145 | Aluminium centre 6"x1.4" <i>(Silver hub and black urethane tyre only)</i> |
| Castor Forks | |
| <input type="checkbox"/> XC192 | Anti-Flutter castor fork <i>(Std when no option selected)</i> |
| <input type="checkbox"/> XC210 | Froglegs suspension castor fork |
| <p>Note: Colour follows accent</p> <div style="display: flex; justify-content: center; align-items: center;"> <p>i <input type="checkbox"/> Black <input type="checkbox"/> Silver</p> </div> | |
| Castor Pin Width | |
| <input checked="" type="checkbox"/> XY330 | Castor pin width <i>(XY010 plus 70mm)</i> |
| | |
| Wheel Lock Options (Choose one) | |
| <input type="checkbox"/> XD020 | Underseat Scissor |
| <input type="checkbox"/> XD030 | Compact scissor |
| <input type="checkbox"/> XD035 | Compact scissor with lightweight fixing <i>(Only with fixed centre of gravity)</i> |
| <input type="checkbox"/> XD010 | Omit wheel locks |
| <input type="checkbox"/> XD050 | Push to lock |
| <input type="checkbox"/> XD046 | Out Front push to lock |
| <input type="checkbox"/> XD085 | Eagle Brakes (Indicate colour) |
| <input type="checkbox"/> XD086 | Eagle Brakes with L/W fixing (Indicate colour) <i>(Only with fixed centre of gravity)</i> |
| <div style="display: flex; justify-content: center; gap: 20px;"> <div style="text-align: center;"><input type="checkbox"/> BLACK</div> <div style="text-align: center;"><input type="checkbox"/> PURPLE</div> <div style="text-align: center;"><input type="checkbox"/> RED</div> <div style="text-align: center;"><input type="checkbox"/> BLUE</div> </div> <p>Black Std if no option selected</p> | |

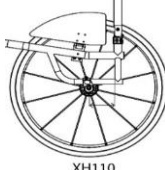
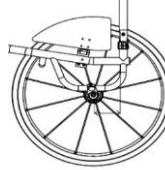
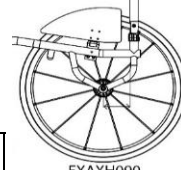
| SIDEGUARDS AND ARMRESTS | |
|--|---|
| <p style="text-align: center;">Sideguard</p> <p style="text-align: center;">Aluminium Options</p> <p><input type="checkbox"/> XE080 Lift out aluminium</p> <p><input type="checkbox"/> FXTXE130 Fold flat aluminium</p> <p style="text-align: center;">Carbon Fibre Options</p> <p><input type="checkbox"/> XE100 Lift out carbon fibre</p> <p><input type="checkbox"/> FXTXE150 Fold flat carbon fibre</p> <p style="text-align: center;">ABS Plastic Options</p> <p><input type="checkbox"/> XE120 Lift out ABS plastic</p> <p><input type="checkbox"/> FXTXE170 Fold flat ABS plastic</p> | <p style="text-align: center;">Sideguard with Fender</p> <p style="text-align: center;">Aluminium Options</p> <p><input type="checkbox"/> XE090 Lift out aluminium with fender</p> <p><input type="checkbox"/> FXTXE140 Fold flat aluminium with fender</p> <p style="text-align: center;">Carbon Fibre Options</p> <p><input type="checkbox"/> XE110 Lift out carbon fibre with fender</p> <p><input type="checkbox"/> FXTXE160 Fold flat carbon fibre with fender</p> <p style="text-align: center;">Sideguard Measurements</p> <p style="text-align: center;">Fender height</p> <p><input type="checkbox"/> 10mm above tyre <i>(Standard)</i></p> <p><input type="checkbox"/> Individual above tyre <i>(Min = 10mm)</i></p> <p><input type="checkbox"/> <input style="width: 100px;" type="text"/> mm</p> <p style="text-align: center;">Fender position</p> <p><input type="checkbox"/> Centre of tyre <i>(Standard if no option selected)</i></p> <p><input type="checkbox"/> Outside of tyre</p> <p style="text-align: center;">Armrest Options</p> <p><input type="checkbox"/> XF010 Lift out armrest with plastic sideguard <i>(Indicate fixed height)</i></p> <p><input type="checkbox"/> XF020 Lift out armrest with Aluminium sideguard <i>(Indicate fixed height)</i></p> <p style="text-align: center;"><i>Height (Top of seatrail to top of armrest)</i></p> <p><input type="checkbox"/> <input style="width: 100px;" type="text"/> mm</p> |
| <p style="text-align: center;">Sideguard Measurements</p> <p style="text-align: center;">Optimised measurements</p> <p><input type="checkbox"/> 25mm above tyre <i>(Follow tyre)</i></p> <p><input type="checkbox"/> Individual above tyre <i>(Follow tyre)</i></p> <p><input type="checkbox"/> <input style="width: 100px;" type="text"/> mm</p> <p><input type="checkbox"/> Level with tyre <i>(Follow tyre)</i></p> <p style="text-align: center;">Individual measurements</p> <p><input type="checkbox"/> Sideguard length <input style="width: 100px;" type="text"/> mm</p> <p><input type="checkbox"/> Sideguard height <input style="width: 100px;" type="text"/> mm</p> | |

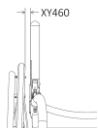
| BACKREST | |
|---|---|
| Backrest Height | |
| <input type="checkbox"/> XY230 Fixed height backrest (Maximum 400mm) Specify height <input type="text" value=""/> mm | <input type="checkbox"/> XY245 Adjustable height backrest (Maximum height 400mm) (+/-25mm) Specify height <input type="text" value=""/> mm |
| | |
| Backrest Design | |
| <input checked="" type="checkbox"/> FXTXG060 Folding backrest with Q Lock (Black) | |
| Ergonomic Options | |
| <input checked="" type="checkbox"/> XY360 Backrest angle <input type="checkbox"/> -5 <input type="checkbox"/> -3 <input type="checkbox"/> 0 <input type="checkbox"/> +3 <input type="checkbox"/> +5 Individual <input type="text" value=""/> Deg (Max -7/+7 Deg) | <input type="checkbox"/> XG100 Ergonomic backrest Vertical height <input type="text" value=""/> mm Rearward position <input type="text" value=""/> mm |
| | |
| <input type="checkbox"/> XG110 Inward taper (inside of backrest posts) Specify width or per side <input type="text" value=""/> mm | <input type="checkbox"/> XG120 Outward flare (inside of backrest posts) Specify width or per side <input type="text" value=""/> mm |
| | |
| Push handle Options | |
| <input type="checkbox"/> XG070 Screw in push handles (N/A with XY245) | |
| <input type="checkbox"/> XG080 Flip down push handles (N/A with XY245) | |
| <input type="checkbox"/> XG085 Flip down push handles height adjustable (N/A with XY245) | |
| <input type="checkbox"/> XG097 Integrated push handle (quickie design) | |

| CAMBER BAR | |
|---|---|
| <p style="text-align: center;">Adjustable Centre of Gravity</p> <p><input type="checkbox"/> XH110 Square back adjustable centre of gravity (25-150mm)</p> <p>(Max seat width 500mm)</p> <p>Specify measurement</p> <p> <input type="text" value=""/> mm</p>  <p style="text-align: center;">XH110</p> <p><input type="checkbox"/> XH120 Round back adjustable centre of gravity (60-150mm)</p> <p>Specify measurement</p> <p> <input type="text" value=""/> mm</p>  <p style="text-align: center;">XH120</p> | <p style="text-align: center;">Fixed Centre of Gravity</p> <p><input type="checkbox"/> FXTXH090 V-style fixed centre of gravity (25-125mm)</p> <p>Specify measurement</p> <p> <input type="text" value=""/> mm</p>  <p style="text-align: center;">FXAXH090</p> |
| Specify Camber Angle | Specify Camber Angle |
| <p><input checked="" type="checkbox"/> XY390 Camber angle</p> <p> <input type="checkbox"/> 0 <input type="checkbox"/> 1 <input type="checkbox"/> 2 <input type="checkbox"/> 3 <input type="checkbox"/> 5</p> | <p><input checked="" type="checkbox"/> XY390 Camber angle</p> <p> <input type="checkbox"/> 0 <input type="checkbox"/> 1 <input type="checkbox"/> 2 <input type="checkbox"/> 3 <input type="checkbox"/> 5</p> |
| Camber Bar Options | |
| <p><input type="checkbox"/> FXTXK227 Standard Axle pin (120 or 130mm)</p> <p><input type="checkbox"/> FXTXK226 100mm Titanium Axle pin (Fixed Axle only)</p> | <p><input type="checkbox"/> XK220 Titanium 130mm quick release axle pins (pair) (N/A with XK010, XK070 or FXTXK226)</p> <p><input type="checkbox"/> XK240 Quad release axle nuts (pair) (N/A with FXTXK226)</p> |
| Anti-Tip Options | |
| <p><input type="checkbox"/> XJ010 Swingaway anti tip LEFT side (Only with square back frame. Not with XH040)</p> <p><input type="checkbox"/> XJ020 Swingaway anti tip RIGHT side (Only with square back frame. Not with XH040)</p> | <p><input type="checkbox"/> XJ100 Single sport anti tip (centre mounted)</p> |

| REAR WHEELS | |
|--|--|
| Rear Wheel Size | |
| <input type="checkbox"/> XY420 24" Wheels | <input type="checkbox"/> XY430 25" Wheels |
| Rear Wheel Gap | |
| <input checked="" type="checkbox"/> XY460 Rear wheel gap |  |
| <input type="checkbox"/> 15 <input type="checkbox"/> 20 <input type="checkbox"/> 25  | Individual <input type="text" value=""/> mm |
| Rear Wheel Options | |
| <input type="checkbox"/> XK010 Fusion 16 spoke <i>(Silver Hub, black spokes)</i> | <input type="checkbox"/> XK320 Spinergy XLX 12 spoke, cross/radial spoked |
| <input type="checkbox"/> XK050 Spinergy LX 12 spoke | <input type="checkbox"/> XK060 Spinergy SPOX 18 spoke |
| <input type="checkbox"/> XK150 Spinergy CLX 18 carbon blade spoke N/A IN SILVER HUB | <input type="checkbox"/> XK070 Spinergy BLXL 18 blade spoke N/A IN SILVER HUB |
| <input type="checkbox"/> XK155 Spinergy CX6 18 carbon blade spoke N/A IN SILVER HUB | |
| Spinergy Colour Options:  | |
| <input type="checkbox"/> Black spokes | <input type="checkbox"/> White spokes |
| <input type="checkbox"/> Red spokes | <input type="checkbox"/> Blue spokes |
| <input type="checkbox"/> Purple spokes | <input type="checkbox"/> Orange spokes |
| <input type="checkbox"/> Yellow spokes | <input type="checkbox"/> Pink spokes |
| <input type="checkbox"/> Green spokes | <input type="checkbox"/> XK180 Individual spoke design <i>(Specify colour)</i> |
| | Inside: _____ |
| | Outside: _____ |
| Spinergy Anodise Options | |
| <input type="checkbox"/> XK190 Black hub <i>(std option)</i> | <input type="checkbox"/> XK200 Silver hub <i>(n/a with BLXL/CLX)</i> |
| <input type="checkbox"/> XK202 Purple hub/rims <i>(LX, XLX & BLXL only)</i> | <input type="checkbox"/> XK203 Blue hub/rims <i>(LX, XLX & BLXL only)</i> |
| <input type="checkbox"/> XK201 Red hub/rims <i>(LX, XLX & BLXL only)</i> | <input type="checkbox"/> XK204 Gold hub/rims <i>(LX, XLX & BLXL only)</i> |
| <input type="checkbox"/> XK205 Individual hub/rims Select colour: _____ | |
| Supply Without Wheels | |
| <input type="checkbox"/> XK040 Supply without Wheels |  Wheel Type: <input type="text" value=""/> Tyre Type: <input type="text" value=""/> |
| Handrim Position / Options | |
| <input type="checkbox"/> XY480 Narrow set handrim | <input type="checkbox"/> XY485 Wide set handrim |
| <input type="checkbox"/> XL090 Remove excess mounting tabs <i>(recommended for small wheel gaps)</i> | |
| Handrim Styles | |
| <input type="checkbox"/> XL010 Aluminium hard anodised 6 tab <i>(Standard if no option selected)</i> | <input type="checkbox"/> XL040 Titanium 6 tab |
| <input type="checkbox"/> XL160 Eclipse 6 tab <i>(replacement for Surge)</i> | <input type="checkbox"/> XL035 Natural Fit LT |
| <input type="checkbox"/> XL020 Tetra grip 6 tab | <input type="checkbox"/> XL150 Carbolife Gekko <input type="checkbox"/> Black <input type="checkbox"/> Silver |
| <input type="checkbox"/> XL100 Para grip 6 tab | <input type="checkbox"/> NEW Carbolife Curve L <i>(Black)</i> |
| Tyre Options | |
| <input type="checkbox"/> XM010 Kenda <input type="checkbox"/> Grey <input type="checkbox"/> Blue <input type="checkbox"/> Red <i>(Std)</i> | <input type="checkbox"/> XM060 Schwalbe One <i>(24", 25" only)</i> |
| <input type="checkbox"/> XM130 Kenda black | <input type="checkbox"/> XM050 Kenda K885 mountain bike tyre <i>(24", 25" only)</i> |
| <input type="checkbox"/> XM020 Schwalbe Marathon Plus | |
| <input type="checkbox"/> XM040 Shox solid airless <i>(Black)</i> | |
| Inner Tube Valve Options | |
| <input type="checkbox"/> XY500 Schraeder inner tube valve <i>(Standard if no option selected)</i> | <input type="checkbox"/> XY490 Presta inner tube valve |
| Wheel Accessories | |
| <input type="checkbox"/> XK310 Offroad wheel set 24" rim with handrim, MTB tyre and axle pins <i>(Replaces 25" wheel with XM010)</i> | <input type="checkbox"/> XK300 Offroad wheel set 22" rim with handrim, MTB tyre and axle pins <i>(Replaces 24" wheel with XM010)</i> |

| FINISH OPTIONS | | | |
|---|--|---|---|
| Frame & Component Finish | | | |
| <input type="checkbox"/> XN010 | Powder coated frame | <input type="checkbox"/> XN150 | Powder coated components (Frame colour if not specified) |
| Frame Comp. | Gloss | Frame Comp. | Matt |
| <input type="checkbox"/> <input type="checkbox"/> | Black gloss 103 | <input type="checkbox"/> <input type="checkbox"/> | Black matt 105 |
| <input type="checkbox"/> <input type="checkbox"/> | White gloss 100 | <input type="checkbox"/> <input type="checkbox"/> | White matt 101 |
| <input type="checkbox"/> <input type="checkbox"/> | Grey gloss 132 | <input type="checkbox"/> <input type="checkbox"/> | Grey matt 131 |
| <input type="checkbox"/> <input type="checkbox"/> | Cream gloss 135 | <input type="checkbox"/> <input type="checkbox"/> | Light grey matt 133 |
| <input type="checkbox"/> <input type="checkbox"/> | Red gloss 108 | <input type="checkbox"/> <input type="checkbox"/> | Navy blue matt 152 |
| <input type="checkbox"/> <input type="checkbox"/> | Yellow gloss 120 | | |
| <input type="checkbox"/> <input type="checkbox"/> | Forest green gloss 143 | | |
| <input type="checkbox"/> <input type="checkbox"/> | Green gloss 107 | | |
| <input type="checkbox"/> <input type="checkbox"/> | Dark blue gloss 151 | | |
| <input type="checkbox"/> <input type="checkbox"/> | Royal blue gloss 154 | | |
| <input type="checkbox"/> <input type="checkbox"/> | Blue gloss 174 | | |
| <input type="checkbox"/> <input type="checkbox"/> | Duckegg blue gloss 141 | | |
| <input type="checkbox"/> <input type="checkbox"/> | Pink gloss 188 | | |
| <input type="checkbox"/> <input type="checkbox"/> | Orange gloss 180 | | |
| <input type="checkbox"/> <input type="checkbox"/> | Purple gloss 157 | | |
| <input type="checkbox"/> FXTXN030 | Beadblast frame (All parts black unless XN160 chosen) | <input type="checkbox"/> XN160 | Beadblast components |
| <input type="checkbox"/> FXTXN050 | Polished frame (All parts black unless XN170 chosen) | <input type="checkbox"/> XN170 | Polished components |
| | | <input type="checkbox"/> XN200 | Individual paint colour (State Colour/RAL code) |
| | | | Frame Comp |
| | | | <input type="checkbox"/> <input type="checkbox"/> |
| | | | _____ |
| Accent Colour (Choose One) | | | |
| Note: Accent colour includes forks only | | | |
| <input type="checkbox"/> | Black accent | <input type="checkbox"/> | Silver accent |
| <input type="checkbox"/> | Red accent | <input type="checkbox"/> | Blue accent |
| <input type="checkbox"/> | Purple accent | <input type="checkbox"/> XN250 | Individual Accent Colour |
| | | | _____ |
| UPHOLSTERY | | | |
| Seat Upholstery | | | |
| <input type="checkbox"/> XP040 | Seat sling strap adjustable | <input type="checkbox"/> XR050 | Carbon fibre seat plate |
| Backrest Upholstery | | | |
| <input type="checkbox"/> XP050 | Airtech backrest strap adjustable | <input type="checkbox"/> XP060 | Backrest upgrade to full leather (Black) |
| | | <input type="checkbox"/> XP070 | Backrest upgrade to leather corners (Black) |
| RGK Logo Colour | | | |
| <input type="checkbox"/> | White (Std) | <input type="checkbox"/> | Green |
| <input type="checkbox"/> | Red | <input type="checkbox"/> | Orange |
| <input type="checkbox"/> | | <input type="checkbox"/> | Blue |
| <input type="checkbox"/> | | <input type="checkbox"/> | Purple |
| | | <input type="checkbox"/> | Individual: _____ |
| Model Logo Colour | | | |
| <input type="checkbox"/> | White (Std) | <input type="checkbox"/> | Green |
| <input type="checkbox"/> | Red | <input type="checkbox"/> | Orange |
| <input type="checkbox"/> | | <input type="checkbox"/> | Blue |
| <input type="checkbox"/> | | <input type="checkbox"/> | Purple |
| | | <input type="checkbox"/> | Individual: _____ |
| Backrest Accessories | | | |
| <input type="checkbox"/> XP110 | Backrest with zip pocket (N/A with Sub4 backrest) | <input type="checkbox"/> XP170 | Individual backrest embroidery PLEASE COMPLETE PAGE 11 |

| CUSHION | |
|---|---|
| Cushion foam options | |
| <input type="checkbox"/> XP080 | Cushion foam <i>(select density and size below)</i> |
| <input type="checkbox"/> | Soft (CMS040) |
| <input type="checkbox"/> | Medium (CMS050) |
| <input type="checkbox"/> | 50mm |
| <input type="checkbox"/> | 75mm |
| <input type="checkbox"/> | 100mm |
| Cushion cover upgrades | |
| <input type="checkbox"/> XP085 | Nylon cushion cover <i>(Black)</i> |
| <input type="checkbox"/> XP090 | Air Lite cushion cover <i>(Black)</i> |
| <input type="checkbox"/> XP100 | Leather cushion cover <i>(Black)</i> |
| Jay Products - PLEASE PROVIDE JAY ORDER FORM | |
| <input type="checkbox"/> JAY Cushion <i>(Price dependant on size / option)</i> | <input type="checkbox"/> <i>Jay Order form attached</i> |
| <input type="checkbox"/> JAY Backrest <i>(Price dependant on size / option)</i> | <input type="checkbox"/> <i>Jay Order form attached</i> |
| <input type="checkbox"/> JAY Whitmyer Headrest <i>(Price dependant on size / option)</i> | <input type="checkbox"/> <i>Jay Order form attached</i> |
| ACCESSORIES | |
| <input type="checkbox"/> XR080 | Frontwheel assembly <i>(Only with tubular style footrest))</i> |
| <input type="checkbox"/> XP120 | Frame protectors Neoprene zip fasten <i>(Black)</i> |
| <input type="checkbox"/> XP420 | Frame protectors Nylon velcro fasten <i>(Black)</i> |
| <input type="checkbox"/> XR010 | Seat pouch velcro attach <i>(Black)</i> |
| <input type="checkbox"/> XR200 | Rucksack with RGK logo (Black) |
| <input type="checkbox"/> XR100 | FX carry bag |
| <input checked="" type="checkbox"/> XR090 | Tool kit |
| <input checked="" type="checkbox"/> XS060 | Calf strap |

DONATE / PART EXCHANGE

Donate your old chair for up to off this order*

*Participating RGK resellers only. Any donation chair must include a functional frame and wheels. RGK will replace the upholstery and arrange delivery to a worthy cause.

Chair Make/Model: _____

Chair Serial/Ref No: _____

Agreed Value: _____

Part Exchange your old chair for up to off this order*

*Participating RGK resellers only. Any Part Exchange chair must be less than 5 years old and include a functional frame, componentry and wheels.

Chair Make/Model: _____

Chair Serial/Ref No: _____

Agreed Value: _____

ADDITIONAL NOTES

INDIVIDUAL BACKREST EMBROIDERY

PLEASE PROVIDE JPEG IMAGE AT TIME OF ORDER AND NOTE POSITION BELOW



SPEC NOTES: