

SERIAL NO: \_\_\_\_\_



**Customer Contact Details**

Customer Name: _____ Advisor: _____ Address: _____ _____ _____ Phone: _____ Email: _____	Ship to Customer Address: <input type="checkbox"/> Shipping Name: _____ Shipping Address: _____ _____ _____ Phone: _____ Email: _____
--	---

**Additional Information**

Notes: _____ _____ _____ _____	Current Wheelchair: _____ Customer Weight: _____ Customer Height: _____ Customer Disability: _____
---	---

**Other**

<p><b>VAT Exemption Declaration (UK Only):</b>                  I declare that I am chronically sick or disabled by reason of:                  _____                  and that I am receiving from RGK Wheelchairs Ltd, the wheelchair specified herein and I claim relief from Value Added Tax under group 12 of schedule 8 to Value Added Tax Act 1994.                  Signature: _____ Date: _____</p>	<p><b>RGK Contact Authorisation:</b>                  From time to time, RGK would like to send you exclusive information, news and offers on everything RGK, by email or post. We will not pass any of your details to any third party.                  I would like to be contacted by RGK: <input type="checkbox"/>                  Signature: _____ Date: _____</p>
--	---

Guide:

- Base product
- Required option
- Optional Extra
- Critical Information
- Information Needed
- Non certified Sub4 weight option

## PRODUCT STYLE

SBAXZ010 TIGA SUB4

XA070 Open design

**Max User Weight 110kg (242lbs)**

**PLEASE NOTE: ALL RGK CHAIRS ARE HAND BUILT AND HAVE A MANUFACTURING MEASUREMENT TOLERANCE OF +/- 5MM**

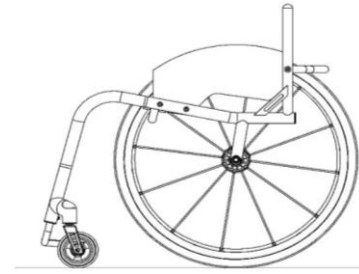

## CAD APPROVAL

XW009 QUOTE ONLY (NO CAD FOR APPROVAL)

XW011 ORDER (NO CAD FOR APPROVAL)

XW012 QUOTE CAD drawing for approval  
(2 customer amendments ONLY)

XW010 ORDER CAD drawing for approval  
(2 customer amendments ONLY)

## KEY MEASUREMENTS

XY010 Seat width (*Inside of sideguards*)

(Max - 440mm)  
(Min - 250mm)

XY020 Seat length

(Max - 440mm)  
(Min - 250mm)

XY030 Extra seat length (*Provides additional leg support & hand grip*)

(Max - 440mm total seat)

XY050 Front frame height

(Max - 520mm)  
(Min - 380mm)

XY060 Rear frame height

(Max - 500mm)  
(Min - 360mm)

XY070 Frame length

(Max - 625mm)  
(Min = XY020 + XY030 + 140mm)

XY072 Castor position

Optimise measurements

XA020 Ergonomic seat

Specify length  (Standard = 120mm)

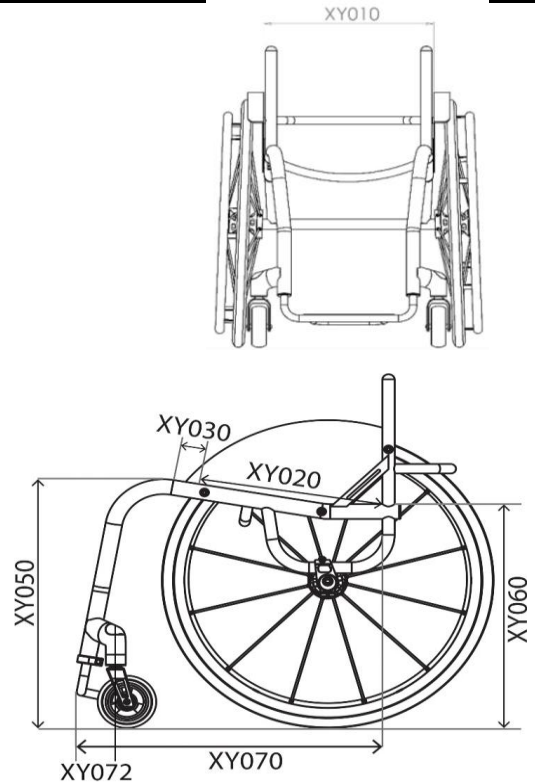

**FRONT FRAME AND FOOTREST**

Front Frame Options

XY080 Seat taper design

**i** Specify width  mm

(When combined with XY091, dimension is inbetween the centre of the main bends)

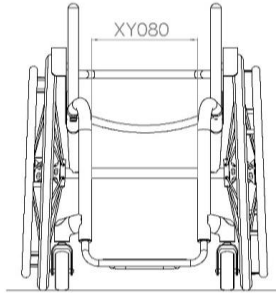

XY091 Parallel taper design

**i** Specify width  mm

(When combined with XY080, dimensions must be smaller by 20mm)

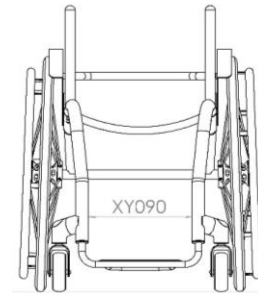

Footrest Design Choose One)

XY100 Round design

Castor Wheel Size	Max Height Achievable
4"	110mm

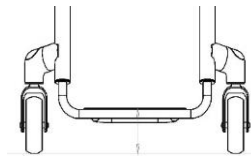

XY105 Square design

Castor Wheel Size	Max Height Achievable
4"	130mm

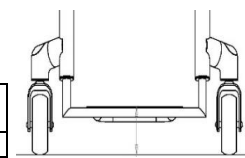

**4**  XB200 High level footrest (Non-certified Sub4 option)

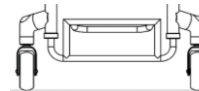

Footrest Measurements

XY115 Front footrest height

**!**  mm

XY120 Rear footrest height

**i**  mm

Std = 20 lower than front height

XY125 Footrest length

**i**  mm

Maximum length 140mm (Certified weight)  
(160mm and over requires heavy duty upgrade XB150)

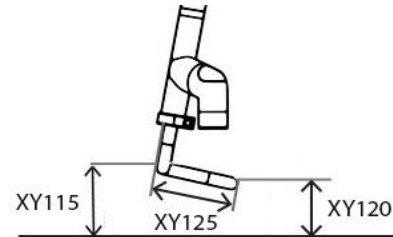

Footrest Style

XB010 Tubular aluminium footrest (Height adjustable)

Footrest Cover

XB045 Lightweight carbon fibre cover (With weight saving cut-out)

**4**  No Cut-Out (Non Certified Sub4 option)

Footplate width Sub4 certified (Std if no option selected)

**4**  Footplate width Standard (optimised plate width) (Non Certified Sub4 option)

**CASTOR WHEELS, FORKS & WHEEL LOCKS**

Castor Wheels

XC135 Aluminium centre 4"x1.25"  
Choose colour below:

- |  |   |
|--|---|
| <input type="checkbox"/> Silver hub & black tyre (Std) | <input type="checkbox"/> Green hub & black tyre |
| <input type="checkbox"/> Black hub & black tyre        | <input type="checkbox"/> Red hub & black tyre   |
| <input type="checkbox"/> Purple hub & black tyre       | <input type="checkbox"/> Blue hub & black tyre  |

XC140 Aluminium centre 5"x1.4" (Non certified Sub4 option)  
(Silver hub and black tyre only)

XC145 Aluminium centre 6"x1.4" (Non certified Sub4 option)  
(Silver hub and black tyre only)

Castor Forks

XC192 Anti-Flutter castor fork  
Note: Colour follows accent

Castor Pin Width

XY330 Castor pin width  
Optimise measurements  
(Minimum width for clear castor rotation and maximum wheelbase length)



Wheel Lock Options

- SBAXD036 Compact scissor with lightweight fixing
- XD020 Underseat scissor (Non certified Sub4 option)
- XD050 Push to lock (Non certified Sub4 option)
- XD010 Omit wheel locks

- SBAXD085 Eagle Brakes (Indicate colour)  
(Non Certified Sub4 option)
- SBAXD086 Eagle Brakes with L/W fixing (Indicate colour)  
(Only with fixed centre of gravity)  
(Non Certified Sub4 option)
- BLACK     PURPLE     RED     BLUE
- Black Std if no option selected

**SIDEGUARDS**

Sideguard

XE055 Screw on lightweight carbon fibre

Sideguard with Fender

XE065 Screw on lightweight carbon fibre w/fender

Sideguard Measurements

Individual above tyre (Follow tyre - max. 25mm)

Level with tyre (Follow tyre)

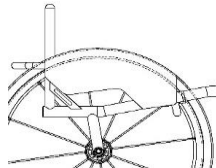



Sideguard Measurements

10mm above tyre (Standard)

Individual above tyre (Min = 10mm)

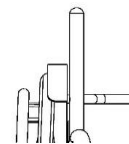
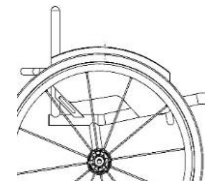
Centre of tyre

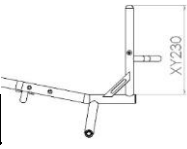
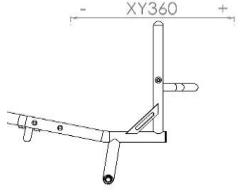
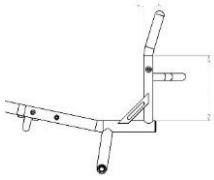
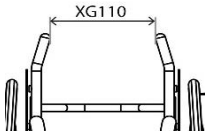
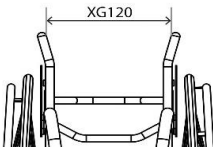

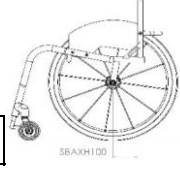
BACKREST	
Backrest Measurements	
<p><input checked="" type="checkbox"/> XY230 Backrest height</p> <p>Specify height <input style="width: 100px;" type="text"/> mm</p> 	<p><input type="checkbox"/> XG010 Fixed Backrest (non-folding)</p> <p><input checked="" type="checkbox"/> SBAXG020 Folding backrest with 2 position snap lock and angle adjust <b>(Non certified Sub4 option)</b></p>
Ergonomic Options	
<p><input checked="" type="checkbox"/> XY360 Backrest angle</p> <p>Individual <input type="checkbox"/> -5 <input type="checkbox"/> -3 <input type="checkbox"/> 0 <input type="checkbox"/> +3 <input type="checkbox"/> +5</p> <p><input style="width: 100px;" type="text"/> Deg (Max -10/+20 Deg)</p> 	<p><input type="checkbox"/> XG100 Ergonomic backrest</p> <p>Vertical height <input style="width: 100px;" type="text"/> mm</p> <p>Rearward position <input style="width: 100px;" type="text"/> mm</p> 
<p><input type="checkbox"/> XG110 Inward taper (inside of backrest posts)</p> <p>Specify width or per side <input style="width: 100px;" type="text"/> mm</p> 	<p><input type="checkbox"/> XG120 Outward flare (inside of backrest posts)</p> <p>Specify width or per side <input style="width: 100px;" type="text"/> mm</p> 
CAMBER BAR	
<p style="text-align: center;">Specify Camber Angle</p> <p><input checked="" type="checkbox"/> XY390 Camber angle</p> <p><input type="checkbox"/> 1 <input type="checkbox"/> 2 <input type="checkbox"/> 3</p> 	<p style="text-align: center;">Centre of Gravity</p> <p><input type="checkbox"/> SBAXH100 Single post fixed centre of gravity (25-125mm)</p> <p><input style="width: 100px;" type="text"/> mm</p>  <p><input checked="" type="checkbox"/> SBAXH130 Square back adjustable centre of gravity (25-125mm) <b>(Non Certified Sub4 option)</b></p> <p><input style="width: 100px;" type="text"/> mm</p> <p><input checked="" type="checkbox"/> SBAXH140 Round back adjustable centre of gravity (60-125mm) <b>(Non Certified Sub4 option)</b></p> <p><input style="width: 100px;" type="text"/> mm</p>
PUSH HANDLES	
<p><input checked="" type="checkbox"/> XG070 Screw in push handles <b>(Non Certified Sub4 option)</b></p>	<p><input checked="" type="checkbox"/> XG080 Flip down push handles <b>(Non Certified Sub4 option)</b></p>
ANTI-TIP	
<p><input checked="" type="checkbox"/> XJ100 Single sport anti tip <b>(Non Certified Sub4 option)</b></p>	

FRAME FINISH OPTIONS			
Frame and Footrest			
<input type="checkbox"/> SBAXN030	Brushed frame	<input checked="" type="checkbox"/> XN010	Powder coat frame
<input type="checkbox"/> SBAXN050	Polished frame	Paint code	<input style="width: 100%;" type="text"/>
Accent Colour (Choose One)			
<i>Note: Accent colour includes, forks &amp; castor caps.</i>			
<input type="checkbox"/> Black accent	<input type="checkbox"/> Silver accent	<input type="checkbox"/> XN250	Individual Accent Colour
<input checked="" type="checkbox"/> Red accent	<input type="checkbox"/> Blue accent		
<input type="checkbox"/> Purple accent	<input type="checkbox"/> Carbon accent		
<i>(Castor caps only, black for rest)</i>			
UPHOLSTERY			
Seat Upholstery			
<input type="checkbox"/> XP045	Sub4 Seat sling strap adjustable	<input checked="" type="checkbox"/> XR050	Carbon fibre seat plate <b>(Non certified Sub4 option)</b>
Backrest Upholstery			
<input type="checkbox"/> XP035	Airtech Sub4 backrest strap adjustable	<input checked="" type="checkbox"/> XP050	Airtech backrest strap adjustable <b>(Non certified Sub4 option)</b>
		<input checked="" type="checkbox"/> XP070	Backrest upgrade to leather corners (Black) <b>(only with Airtech upholstery XP050)</b> <b>(Non certified Sub4 option)</b>
		<input checked="" type="checkbox"/> XP110	Backrest with zip pocket <b>(only with Airtech upholstery XP050)</b> <b>(Non certified Sub4 option)</b>
		<input checked="" type="checkbox"/> XP170	Individual backrest embroidery <i>Please complete page 9</i> <b>(only with Airtech upholstery XP050)</b>
Backrest Upholstery Stitching Options			
<input type="checkbox"/> Silver	<input type="checkbox"/> Black	<input type="checkbox"/> Blue	<input type="checkbox"/> Individual:
<input type="checkbox"/> Red	<input type="checkbox"/> Orange	<input type="checkbox"/> Purple	
RGK Logo Colour			
<input type="checkbox"/> White (Std)	<input type="checkbox"/> Black	<input type="checkbox"/> Blue	<input type="checkbox"/> Individual:
<input type="checkbox"/> Red	<input type="checkbox"/> Orange	<input type="checkbox"/> Purple	

4 REAR WHEELS (* non certified weight options)	
Rear Wheel Size	
<input type="checkbox"/> XY420    24" Wheels	<input type="checkbox"/> XY430    25" Wheels
Rear Wheel Gap	
<input checked="" type="checkbox"/> XY460    Rear wheel gap <input type="checkbox"/> 15 <input type="checkbox"/> 20 <input type="checkbox"/> 25	XY460 
Rear Wheel Options	
<input type="checkbox"/> XK075    Spinergy <b>BLXL</b> 18 blade spoke <i>N/A IN SILVER HUB</i>	<input type="checkbox"/> SBAXK150    Spinergy <b>CLX</b> 18 carbon blade spoke <i>N/A IN SILVER HUB</i>
<input checked="" type="checkbox"/> XK226    Titanium 100mm quick release axle pins	<input type="checkbox"/> SBAXK155    Spinergy <b>CX6</b> 18 carbon blade spoke <i>N/A IN SILVER HUB</i>
Spinergy Colour Options:	
<input type="checkbox"/> Black spokes <input type="checkbox"/> White spokes <input type="checkbox"/> Yellow spokes <input type="checkbox"/> Red spokes <input type="checkbox"/> Blue spokes <input type="checkbox"/> Pink spokes <input type="checkbox"/> Purple spokes <input type="checkbox"/> Orange spokes <input type="checkbox"/> Green spokes	<input type="checkbox"/> XK180    Individual spoke design <i>(Specify colour)</i>  Inside: _____  Outside: _____
Spinergy Anodise Options	
<input type="checkbox"/> XK190    Black hub <i>(std option)</i>	<input type="checkbox"/> XK200    Silver hub <i>(n/a with BLXL/CLX)</i>
<input type="checkbox"/> XK202    Purple hub/rims <i>(LX, XLX &amp; BLXL only)</i>	<input type="checkbox"/> XK203    Blue hub/rims <i>(LX, XLX &amp; BLXL only)</i>
<input type="checkbox"/> XK201    Red hub/rims <i>(LX, XLX &amp; BLXL only)</i>	<input type="checkbox"/> XK205    Individual hub/rims Select colour: _____
<input type="checkbox"/> XK204    Gold hub/rims <i>(LX, XLX &amp; BLXL only)</i>	
Supply Without Wheels	
<input type="checkbox"/> SBAXK040    Supply without Wheels	Wheel Type: <input style="width: 150px;" type="text"/> Tyre Type: <input style="width: 150px;" type="text"/>
Handrim Position / Options	
<input type="checkbox"/> XY480    Narrow set handrim	<input type="checkbox"/> XY485    Wide set handrim
<input type="checkbox"/> XL090    Remove excess mounting tabs <i>(recommended for small wheel gaps)</i>	
Handrim Styles	
<input type="checkbox"/> XL010    Aluminium hard anodised 6 tab <i>(Standard if no option selected)</i>	<input type="checkbox"/> XL040    Titanium 6 tab
<input type="checkbox"/> XL160    Elipse 6 tab <i>(replacement for Surge)</i>	<input type="checkbox"/> XL035    Natural Fit LT
<input type="checkbox"/> XL020    Tetra grip 6 tab	<input type="checkbox"/> XL150    Carbolife Gekko <input type="checkbox"/> Black <input type="checkbox"/> Silver
<input type="checkbox"/> XL100    Para grip 6 tab	<input type="checkbox"/> XL170    Carbolife Curve L (Black)
Tyre Options	
<input type="checkbox"/> XM060    Schwalbe One (Lightest option)	<input type="checkbox"/> XM130    Kenda black
<input type="checkbox"/> XM010    Kenda <input type="checkbox"/> Grey <input type="checkbox"/> Blue <input type="checkbox"/> Red	<input type="checkbox"/> XM050    Kenda K885 mountain bike tyre (24", 25" only)
<input type="checkbox"/> XM020    Schwalbe Marathon Plus	
<input type="checkbox"/> XM040    Shox solid airless	
Inner Tube Valve Options	
<input type="checkbox"/> XY500    Schraeder inner tube valve <i>(Standard if no option selected)</i>	<input type="checkbox"/> XY490    Presta inner tube valve
* Indicates items that are not part of the certified weight of the TIGA Sub4	

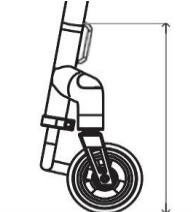
④ CUSHION (** non certified weight options)	
Cushion foam options	
<input type="checkbox"/> XP080	Cushion foam <i>(select density and size below)</i>
<input type="checkbox"/> Soft (CMS040)	<input type="checkbox"/> Medium (CMS050)
<input type="checkbox"/> 50mm	<input type="checkbox"/> 75mm <input type="checkbox"/> 100mm
Cushion cover upgrades	
<input type="checkbox"/> XP085	Nylon cushion cover <i>(Black)</i>
<input type="checkbox"/> XP090	Airlite cushion cover <i>(Black)</i>
<input type="checkbox"/> XP100	Leather cushion cover <i>(Black)</i>
Jay Products - PLEASE PROVIDE JAY ORDER FORM	
<input type="checkbox"/> JAY Cushion <i>(Price dependant on size / option)</i>	<input style="width: 100%;" type="text" value="Refer to Jay Order Form"/>
<input type="checkbox"/> JAY Backrest <i>(Price dependant on size / option)</i>	<input style="width: 100%;" type="text" value="Refer to Jay Order Form"/>
<input type="checkbox"/> JAY Whitmyer Headrest <i>(Price dependant on size / option)</i>	<input style="width: 100%;" type="text" value="Refer to Jay Order Form"/>
④ FRAME OPTIONS (** non certified weight options)	
<input type="checkbox"/> XR060	Welded calf strap mounting loops <i>(To locate calf strap on front frame)</i>
	<i>Specify height from floor</i> <input style="width: 100%;" type="text"/>
<input type="checkbox"/>	<i>Optimise measurements</i>
	
④ ACCESSORIES (** non certified weight options)	
<input type="checkbox"/> XR080	Frontwheel assembly <i>(Only with XB010, TGAXB080, XB150)</i>
<input type="checkbox"/> XP120	Frame protectors Neoprene zip fasten (Black)
<input type="checkbox"/> XP420	Frame protectors Nylon velcro fasten (Black)
<input type="checkbox"/> XR010	Seat pouch velcro attach <i>(Black)</i>
<input type="checkbox"/> XR200	Rucksack with RGK logo (Black)
<input type="checkbox"/> XR020	Underseat large storage bag (Black)
<input checked="" type="checkbox"/> XR090	Tool kit
<input checked="" type="checkbox"/> XS065	Sub4 Calf Strap
** indicates options that, when chosen, will not enable RGK to guarantee a Sub4kg product weight	

**DONATE / PART EXCHANGE**

Donate your old chair for up to off this order\*

\*Participating RGK resellers only. Any donation chair must include a functional frame and wheels. RGK will replace the upholstery and arrange delivery to a worthy cause.

Chair Make/Model: \_\_\_\_\_

Chair Serial/Ref No: \_\_\_\_\_

Agreed Value: \_\_\_\_\_

Part Exchange your old chair for up to off this order\*

\*Participating RGK resellers only. Any Part Exchange chair must be less than 5 years old and include a functional frame, componentry and wheels.

Chair Make/Model: \_\_\_\_\_

Chair Serial/Ref No: \_\_\_\_\_

Agreed Value: \_\_\_\_\_

**ADDITIONAL NOTES**

**INDIVIDUAL BACKREST EMBROIDERY**

PLEASE PROVIDE JPEG IMAGE AT TIME OF ORDER AND NOTE POSITION BELOW



**BRACE BAR**

**SPEC NOTES:**