



Deliver to:
Name:
Street:
Town: Postal code:
E-Mail:
Tel: Fax:



Deliver to:
Name:
Street:
Town: Postal code:
E-Mail:
Tel: Fax:

Order date:
Purchase order:
Number required:

- Order Calculation Built 4 me

Marked for:
Sunrise order no:

- = Standard = Cost option
./ = Price reduction = No cost option

Customer service fax number: +497253 980-222

Max. user weight: 125kg // 140 kg (2)

USER WEIGHT kg

Mandatory information to ensure correct configuration

Art. no.: 65100001

Base Price

CLIENT MEASUREMENTS (all measurements without cushion)

SEAT WIDTH SELECTION - measured from outside frame tube to outside frame tube (mm)

300	320	340	360	380	400	420	440	460	480	500
<input type="radio"/>	<input type="radio"/>	<input type="radio"/>	<input type="radio"/>	<input type="radio"/>	<input type="radio"/>	<input type="radio"/>	<input type="radio"/>	<input type="radio"/>	<input type="radio"/>	<input type="radio"/>

SEAT DEPTH SELECTION - in mm

320	340	360	380	400	420	440	460	480	500	520
<input type="radio"/>	<input type="radio"/>	<input type="radio"/>	<input type="radio"/>	<input type="radio"/>	<input type="radio"/>	<input type="radio"/>	<input type="radio"/>	<input type="radio"/>	<input type="radio"/>	<input type="radio"/>

FRONT SEAT HEIGHT SELECTION: in dependance of front castor size

		Front Seat Height in mm								
		Fork type	450	460	470	480	490	500	510	520
3"	111 mm	<input type="radio"/>	<input type="radio"/>	<input type="radio"/>						
	123 mm (1)			<input type="radio"/>	<input type="radio"/>	<input type="radio"/>				
	111mm	<input type="radio"/>	<input type="radio"/>	<input type="radio"/>	<input type="radio"/>	<input type="radio"/>				
4"	123 mm (1)			<input type="radio"/>	<input type="radio"/>	<input type="radio"/>	<input type="radio"/>			
	Frog leg (1)					<input type="radio"/>	<input type="radio"/>	<input type="radio"/>		
	111mm				<input type="radio"/>	<input type="radio"/>	<input type="radio"/>			
5"	123 mm (1)				<input type="radio"/>	<input type="radio"/>	<input type="radio"/>	<input type="radio"/>		
	Frog leg (1)							<input type="radio"/>	<input type="radio"/>	
	123 mm (1)						<input type="radio"/>	<input type="radio"/>	<input type="radio"/>	
6"	123 mm (1)						<input type="radio"/>	<input type="radio"/>	<input type="radio"/>	

REAR SEAT HEIGHT SELECTION: in dependance of rear wheel size

The The rear seat height can only be between 0 mm and 130 mm below the selected front seat height.

Cau Caution: with rear seat heights 460 mm and above, the width between the sideguards increases by 30 mm

		Rear seat height in mm																	
Rear Wheels	340	350	360	370	380	390	400	410	420	430	440	450	460	470	480	490	500	510	520
22"	<input type="radio"/>	<input type="radio"/>	<input type="radio"/>	<input type="radio"/>	<input type="radio"/>	<input type="radio"/>	<input type="radio"/>	<input type="radio"/>	<input type="radio"/>	<input type="radio"/>	<input type="radio"/>	<input type="radio"/>	<input type="radio"/>	<input type="radio"/>	<input type="radio"/>	<input type="radio"/>	<input type="radio"/>	<input type="radio"/>	<input type="radio"/>
24"			<input type="radio"/>	<input type="radio"/>	<input type="radio"/>	<input type="radio"/>	<input type="radio"/>	<input type="radio"/>	<input type="radio"/>	<input type="radio"/>	<input type="radio"/>	<input type="radio"/>	<input type="radio"/>	<input type="radio"/>	<input type="radio"/>	<input type="radio"/>	<input type="radio"/>	<input type="radio"/>	<input type="radio"/>
25"				<input type="radio"/>	<input type="radio"/>	<input type="radio"/>	<input type="radio"/>	<input type="radio"/>	<input type="radio"/>	<input type="radio"/>	<input type="radio"/>	<input type="radio"/>	<input type="radio"/>	<input type="radio"/>	<input type="radio"/>	<input type="radio"/>	<input type="radio"/>	<input type="radio"/>	<input type="radio"/>
26"						<input type="radio"/>	<input type="radio"/>	<input type="radio"/>	<input type="radio"/>	<input type="radio"/>	<input type="radio"/>	<input type="radio"/>	<input type="radio"/>	<input type="radio"/>	<input type="radio"/>	<input type="radio"/>	<input type="radio"/>	<input type="radio"/>	<input type="radio"/>

(1) compatible with power add on devices
(2) 136kg in combination with AGN090100 "Crash Test Option"



For more information
visit our webpage
www.SunriseMedical.eu

Please follow this measuring method:

The following method is recommended on the basis of extensive practical experience. Deviations are possible in individual instances.

Seat width (SW):

- a) *For the user:* Allow space between sideguard and hip on each side of the chair (approx. 10 - 20 mm altogether)
- b) *On the wheelchair:* From outside frame tube to outside frame tube.

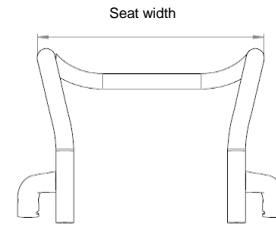

Seat depth (SD):

- a) *For the user:* When sitting upright: leave space for 2 - 3 fingers between front edge of the seat upholstery and back of knee (approx. 30 - 60 mm). Care must be taken with adj. upholstery.
- b) *On the wheelchair:* From back tube to front of seat upholstery.

Front seat height:

- a) *For the user:* When sitting with 90° kneeangle: From back of knee to bottom of shoe sole.
- b) *On the wheelchair:* From front of seat tube to the ground . (min. 30 mm longer than user measurement) Remember to include the cushion height.

Rear seat height:

- b) *On the wheelchair:* From back of seat tube to the ground.
Note: Max. seat height difference rear to front is 130 mm

Back height:

- a) *For the user:* From the seat, including cushion, to be no more than 10 - 20 mm below the lower shoulder blade.
- b) *On the wheelchair:* From back of seat tube to upper edge of backrest upholstery.
Note: The user's ability to sit upright has a major influence on the back height and it can therefore differ considerably

Back angle:

Important: The back height depends on the degree of disability. 0° is the angle 90° to the ground. Negative angles are <90° and positive angles are >90°.

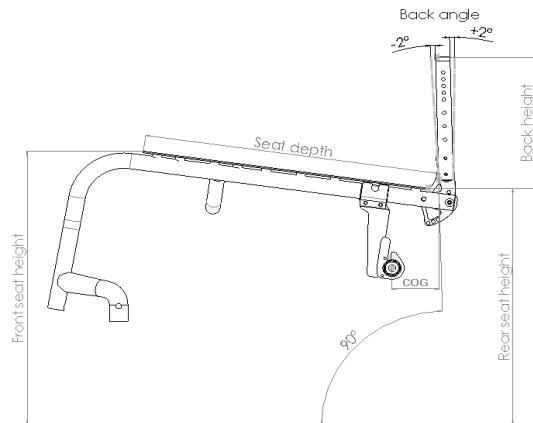

Technical Data Overview:

Overall dimensions:	Overall width with:	24" rear wheel	25" rear wheel
Max overall height: 900 mm	For 0° camber:	SW + 200 mm	SW + 200 mm
Max overall length: 910 mm	For 3° camber:	SW + 220 mm	SW + 260 mm
	For 6° camber:	SW + 280 mm	SW + 320 mm
	For 9° camber:	SW + 340 mm	SW + 380 mm

Please note that the matrix is based on a std configuration:
Std chair 400 x 400 mm; 3° camber; 56 mm CoG; Seat angle of 8°
 All changes in the configuration might change the seat heights.
 Manufacturing tolerances of +/- 10 mm

SEAT UPHOLSTERY AND CUSHIONS

Seat Slings:

AGN020002	●	Seat sling with 1 utility bag	
AGN020003	□	Seat sling with 2 utility bag	(only from SW 340 mm)
AGN020004	□	Seat sling with utility bag and catheter bag	(only from SW 340 mm)
AGN020000	○	Without seat sling	

Seat cushion black cover:

Foam composite: (medium soft)	Thickness:	AGN020101	□ 30 mm	AGN020102	□ 50 mm
Latex: (very soft)	Thickness:	AGN020103	□ 50 mm		

JAY Cushions - for complete product range see Jay order forms:

JAY020002	□	Jay Basic	
JAY020003	□	Jay Soft Combi P	
JAY020001	□	Jay Easy Visco	
JAY020007	□	JAY Easy Fluid	
JAY020004	□	JAY Lite	

Seat accessories

AGN090018	□	Positioning belt	
-----------	---	------------------	--

BACKREST

Back height range

Choose back height factory setting (mm).
Height adjustments possible in the range 250-300 mm; 300-400 mm; 400-450 mm.

250 - 300	300 - 400	400 - 450
○ 250	○ 300	○ 375
○ 275	○ 325	○ 400
○ 300	○ 350	○ 450

AGN030015	●	Angle adj. Back (fold down)	(-31° to +15°)	(only in black anodizing)
AGN030102	□	Double locking		
AGN030012	○	Angle adj. Back (fixed)	(-31° to +15°)	(only in black anodizing)

Pushhandles: Choose only one option

AGN030200	○	Omit push handles	
AGN030201	○	Integral push handles long	
AGN030203	□	Fold-down push handles	(only available from back height 325 mm)
AGN030204	□	Height adj push handles	(only available from back height 325 mm)
AGN030205	□	Height adj push handles for Jay backs	(only available from back height 325 mm)

Backrest upholstery adjustable

AGN030316	○	EXO Backrest sling, padded, adjustable, 1 accessory bag, black (EXO Evo version) Colour, binding tape: ● Black ○ Orange ○ Silver ○ Red ○ Blue	
AGN030317	□	EXO PRO Backrest, padded, adj., breathable spacer fabric, 1 accessory bag, black (EXO Evo version) Colour, binding tape: ● Black ○ Orange ○ Silver ○ Red ○ Blue	
AGN030300	○	Without backrest upholstery	



AGN020002
Seat sling with 1 utility bag



AGN090018
Positioning Belt



JAY020002
Jay Basic
(picture shown without upholstery)



JAY020003
Jay Soft Combi P
(picture shown without upholstery)



JAY020001
Jay Easy Visco
(picture shown without upholstery)



JAY020004
Jay Lite
(picture shown without upholstery)



AGN030201
Integral push handles
long



AGN030203
Fold down push
handles



AGN030205
Height adjustable
push handles for Jay



AGN030316
EXO backrest sling (new EXO
Evo version)



AGN030317
EXO PRO backrest sling
(new EXO Evo version)

Quickie Argon²

● = Standard ○ = No cost option □ = Cost option

Price in €

JAY BACKS plus ACCESSORIES - for complete product range see Jay order forms

Jay 3 Back - Shallow Contour (SC)

Mid Thoracic:	<input type="checkbox"/> JAY030010	Medium 340 mm	<input type="checkbox"/> JAY030033	Tall 380 mm		
Upper Thoracic:	<input type="checkbox"/> JAY030012	Short 420 mm	<input type="checkbox"/> JAY030019	Medium 460 mm	<input type="checkbox"/> JAY030025	Tall 500 mm
Shoulder Height:	<input type="checkbox"/> JAY030015	Short 530 mm	<input type="checkbox"/> JAY030022	Medium 570 mm	<input type="checkbox"/> JAY030028	Tall 610 mm

Jay 3 Back - Mid Contour (MC)

Mid Thoracic:	<input type="checkbox"/> JAY030011	Medium 340 mm	<input type="checkbox"/> JAY030018	Tall 380 mm		
Upper Thoracic:	<input type="checkbox"/> JAY030013	Short 420 mm	<input type="checkbox"/> JAY030020	Medium 460 mm	<input type="checkbox"/> JAY030026	Tall 500 mm
Shoulder Height:	<input type="checkbox"/> JAY030016	Short 530 mm	<input type="checkbox"/> JAY030023	Medium 570 mm	<input type="checkbox"/> JAY030029	Tall 610 mm

JAY J3 Back - Mid Deep Contour (MDC) (150 mm Contour Depth)

Mid Thoracic:	<input type="checkbox"/> JAY030044	Medium - 340 mm	<input type="checkbox"/> JAY030041	Tall - 380 mm		
Upper Thoracic:	<input type="checkbox"/> JAY030045	Short - 420 mm	<input type="checkbox"/> JAY030042	Medium - 460 mm	<input type="checkbox"/> JAY030046	Tall - 500 mm
Shoulder Height:	<input type="checkbox"/> JAY030043	Short - 530 mm	<input type="checkbox"/> JAY030047	Medium - 570 mm	<input type="checkbox"/> JAY030048	Tall - 610 mm

Jay 3 Back Accessories

WHT030415	<input type="checkbox"/> Whitmyer Headrest, COBRA XTRA, flip back	(only with JAY J3 backs)
WHT030416	<input type="checkbox"/> Whitmyer Headrest, AXYS, Standard	(only with JAY J3 backs)
JAY090058	<input type="checkbox"/> JAY Accessory bag	(only with Jay 3 Carbon backs)

SIDEGUARDS & ARMRESTS

AGN040102	<input type="checkbox"/> Aluminium sideguard without fender	
AGN040101	<input type="checkbox"/> Carbon Slim style sideguard	(1)
AGN040103	<input type="checkbox"/> Aluminium sideguard with fender	(min seat height 390 mm)
AGN040104	<input type="checkbox"/> Carbon sideguards with fender	(min seat height 390 mm, not in combination with handbike axle)
AGN040107	<input type="checkbox"/> Composite sideguard detachable	
AGN040108	<input type="checkbox"/> Padded tubular armrest	(not in combination with handbike axle)
Single post armrest with:		
AGN040050	<input type="checkbox"/> short armpad (250 mm)	AGN040051 <input type="checkbox"/> long armpad (360 mm)
AGN040052	<input type="checkbox"/> Tool height adj. armrest (short & long armpad - length adj.)	
AGN040000	<input type="radio"/> w/o Sideguard	

LEGREST & FOOTPLATES

AGN050029	● Tubular footrest lightweight	(lower leg length 360 mm - 500 mm)
AGN050030	<input type="checkbox"/> Tubular footrest lightweight with flat cover	(lower leg length 360 mm - 500 mm)
AGN050025	<input type="checkbox"/> Platform footrest LW composite plate	(lower leg length 360 mm - 500 mm)
AGN050024	<input type="checkbox"/> Platform footrest LW alu plate	(lower leg length 360 mm - 500 mm)
AGN050026	<input type="checkbox"/> Platform footrest LW carbon plate	(lower leg length 360 mm - 500 mm)
AGN050034	<input type="checkbox"/> Platform footrest LW high mount	(LLL 220 - 390 mm)
AGN050125	<input type="checkbox"/> Performance footrest alu angle adj.	(lower leg length 360 mm - 500 mm)
AGN050127	<input type="checkbox"/> Foot positioning plate	(only with platform footplates lightweight & performance footplate)
AGN050020	<input type="checkbox"/> Composite footplate divided	(2) (SW 380-500 mm; LLL 380 - 500 mm)
AGN050022	<input type="checkbox"/> Alu footplate divided	(2) (SW 340 - 5000 mm; LLL 380 mm - 500 mm)

Lower leg length (LLL) Attention: LLL has to be 30 mm less than seat height front; all measurements are in mm

<input type="radio"/> 220	<input type="radio"/> 230	<input type="radio"/> 240	<input type="radio"/> 250	<input type="radio"/> 260	<input type="radio"/> 270	<input type="radio"/> 280	<input type="radio"/> 290
<input type="radio"/> 300	<input type="radio"/> 310	<input type="radio"/> 320	<input type="radio"/> 330	<input type="radio"/> 340	<input type="radio"/> 350	<input type="radio"/> 360	<input type="radio"/> 370
<input type="radio"/> 380	<input type="radio"/> 390	<input type="radio"/> 400	<input type="radio"/> 410	<input type="radio"/> 420	<input type="radio"/> 430	<input type="radio"/> 440	<input type="radio"/> 450
<input type="radio"/> 460	<input type="radio"/> 470	<input type="radio"/> 480	<input type="radio"/> 490	<input type="radio"/> 500			

LLL 220 - 350 mm only with high mounted foodrest; for all other foodrests from LLL 360 - 500 mm.

FRAME VERSIONS (first choose frame angle then frame inset)

AGN010601	● User Weight max.125kg	
AGN010602	<input type="checkbox"/> User Weight max.140kg	
AGN010013	<input type="checkbox"/> Fixed frame 92 Degree	
AGN010012	● Fixed frame 100 Degree	
AGN010100	● Frame inset: 0mm	
AGN010103	<input type="checkbox"/> Frame inset: 30mm	
AGN090015	<input type="checkbox"/> Preparation for add on devices (4)	(max. 120 kg; only 0° camber)
AGN010500	<input type="checkbox"/> Handbike axle	(3) (max 100 kg; not in combination with amputee axle and padded tubular armrest)
AGN070500	<input type="checkbox"/> Amputee axle	(not in combination with handbike axle and padded tubular armrest)

- (1) With 24" rear wheel min. rear seat height 410 mm; with 25" rear wheel min. rear seat height 430 mm
 (2) With 30 mm inset divided footplates are available from SW 420 composite and SW 380 alu footplate
 (3) Not with tip assist
 (4) Necessary for e-fix or P105 attachment

For more information
 visit our webpage
www.SunriseMedical.eu
 © Sunrise Medical 2024

Jay 3 Back Shallow Contour Jay 3 Back Mid Contour Jay 3 Back Deep Contour Jay 3 Back Posterior Deep Contour



AGN040102
Aluminum sideguard w/o fender



AGN040101
Slim style sideguard



AGN040103
Aluminum sideguard with fender



AGN040104
Carbon sideguard with fender



AGN040107
Composite sideguard detachable



AGN040108
Padded tubular armrest



AGN040051
Single post armrest with long armpad



AGN040052
Tool height adj. armrest

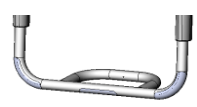

AGN050029
Tubular footrest lightweight



AGN050030
Tubular footrest lightweight with flat cover



AGN050025
Platform footrest LW composite plate



AGN050026
Platform footrest LW carbon plate



AGN050125
Performance footrest alu angle adj



AGN050127
Foot positioning plate



AGN050020
Composite footplate divided



AGN050022
Alu footplate divided

Frame inset table (Graphs below are showing an example for SW 340)

Inset		Seat Width (mm)										
		300	320	340	360	380	400	420	440	460	480	500
0 mm	Frame Width Inside	240	260	280	300	320	340	360	380	400	420	440
	Frame Width Casterhouse	410	430	450	470	490	510	530	550	570	590	610
30 mm	Frame Width Inside	NA	NA	220	240	260	280	300	320	340	360	380
	Frame Width Casterhouse	NA	NA	400	420	440	460	480	500	520	540	560

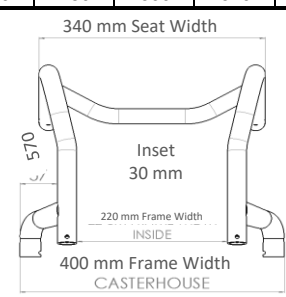
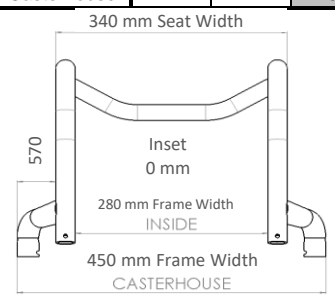

Quickie Argon²

● = Standard ○ = No cost option □ = Cost option

Price in €

CENTRE OF GRAVITY (COG)

(all measurements are in mm; measured from front of back post; choose only one option)

COG32	<input type="radio"/>	32 mm
COG44	<input type="radio"/>	44 mm
COG56	<input type="radio"/>	56 mm
COG68	<input type="radio"/>	68 mm
COG80	<input type="radio"/>	80 mm
COG92	<input type="radio"/>	92 mm
COG104	<input type="radio"/>	104 mm

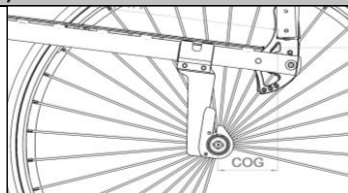

FRAME ACCESSORIES

(choose either tip assist or anti-tip tubes, not both)

Tip assist (step tube)		
AGN090001	<input type="checkbox"/> Left AGN090002 <input type="checkbox"/> Right	
AGN090003	<input type="checkbox"/> Pair	
AGN090009	<input type="checkbox"/> Crutch holder	(only in combination with tip assist)
Anti-tip tubes swing-away		
AGN090004	<input type="checkbox"/> Left AGN090005 <input type="checkbox"/> Right	
AGN090006	<input type="checkbox"/> Pair	
Anti-tip tubes pluggable		
AGN090007	<input type="checkbox"/> Anti-tip tubes pluggable	(Pair)
Anti tip flip up (user operated)		
AGN090033	<input type="checkbox"/> Left AGN090008 <input type="checkbox"/> Right	
AGN090035	<input type="checkbox"/> Sport anti-tip	
AGN090010	<input type="checkbox"/> Transit wheels	(3")
AGN090016	<input type="checkbox"/> Frame protection	

Preparation for ATTITUDE add-on bike

AGN090211	<input type="checkbox"/> Preparation for ATTITUDE, w/o ATTITUDE order (2)	(docking pins assembled)
AGN090212	<input type="radio"/> Preparation for ATTITUDE, with ATTITUDE order (2)	(docking pins assembled; ATTITUDE order separately)

EMPULSE F55 BUNDLING*soon

EMO000101	<input type="radio"/> With F55 order, not mounted to the wheelchair	(Please use separate OF to order the F55. Not with suspension, not with Lightweight Compact brake)
EMO000102	<input type="radio"/> With F55 order, mounted to the wheelchair	(Please use separate OF to order the F55. Not with suspension, not with Lightweight Compact brake)

FORKS

(compare with your choice on the first page)

AGN080013	<input checked="" type="radio"/> Carbotecture fork (111mm forks only)	(colours: see Stylepackage on last page)
AGN080029	<input checked="" type="radio"/> Aluminium fork (123 mm forks only) (3)	(colours: see Stylepackage on last page)
AGN080007	<input type="checkbox"/> FROG LEG fork	(not in combination with 3", 6" & all ALU castors; only black, max user weight 125 kg)

STANDARD CASTOR

(compare with your choice on the first page)

AGN080301	<input type="radio"/> Solid	
AGN080302	<input type="radio"/> Soft	(only for 5" & 6")
AGN080303	<input type="checkbox"/> Solid light up	(not available for 6")
AGN080304	<input type="checkbox"/> Solid with aluminium rim	(only for 4" and 5")
AGN080306	<input type="checkbox"/> Soft with aluminium rim	(only for 4" and 5")

REAR WHEELS

(compare with your choice on the first page; choose only one wheel type)

NOTE: for users with higher user weight than 100 kg, we recommend cross spoked wheels

AGN070001	<input type="radio"/> Universal Cross spoked	(22", 24", 26")
AGN070002	<input type="radio"/> Design wheel	(24", 26")
AGN070003	<input type="radio"/> Light weight wheel	(22", 24", 25"; max user weight: 125 kg)
AGN070004	<input type="checkbox"/> Proton Wheels	(22", 24", 25"; max user weight: 100 kg)
AGN070005	<input type="checkbox"/> Spinergy wheels 18 spokes (1)	(24", 25", 26"; black spokes; other colours available via B4M)
AGN070007	<input type="checkbox"/> Spinergy wheels 12 spokes	(24", 25"; black spokes, black hub)
AGN070009	<input type="checkbox"/> Mountainbike Rear wheel	(only with 24", mountain bike tyres & aluminium rim, black coated)
AGN070010	<input type="checkbox"/> Additional Mountain Bike wheels	(only with 24"; comes always with mountainbike tyres.)
AGN070000	<input type="radio"/> Without wheels	

TYRES

(choose only one tyre type)

AGN070101	<input type="radio"/> Right Run	(not in 25")
AGN070107	<input type="checkbox"/> Schwalbe One	(only 24" and 25")
AGN070102	<input type="radio"/> Solid tyres (2)	(not with 26")
AGN070104	<input type="checkbox"/> Marathon plus evolution (puncture proof)	(not in 22")
AGN090163	<input type="checkbox"/> Spares-kit: 1 extra tyre (same as on the chair) and 1 extra inner tube	(not with solid tyres)

- (1): **Proton and Light Weight wheel only with 22", 24" & 25" solid tyre ; Spinergy wheels only with 24" solid tyre**
Not with Mountainbike wheel
- (2): **Max front frame width 46 mm, max 100kg user weight**
- (3): **compatible with power add on devices**

For more information
 visit our webpage
www.SunriseMedical.eu



AGN090001
Tip assist left



AGN090004
Anti-tip tubes SA



AGN090007
Anti tip tubes pluggable



AGN090035
Sport anti-tip



AGN090008
Anti tip flip up
User operated



AGN090010
Transit wheels



AGN090016
Frame protection



AGN080013
Carbotecture fork



AGN080007
FROG LEG fork



AGN070001
Universal Cross spoked



AGN070002
Design Wheel



AGN070003
Light weight wheel



AGN070004
Proton Wheel



AGN070004
Spinergy Wheel



AGN070101
Right Run



AGN070107
Schwalbe One



AGN070102
Solid Tyres



AGN070104
Marathon Plus
(puncture proof)



AGN070009
Mountain bike rear
wheel

Quickie Argon²

● = Standard

○ = No cost option

□ = Cost option

Price in €

HANDRIM

AGN070201	<input type="radio"/>	Aluminium silver powder coated	(not with 26" Spinergy wheels)	
AGN070202	<input type="radio"/>	Aluminium silver anodized		
AGN070203	<input type="checkbox"/>	Aluminium colour powder coated		
AGN070204	<input type="radio"/>	Stainless steel		
AGN070205	<input type="checkbox"/>	Titanium	(not with 22" wheels)	
AGN070206	<input type="checkbox"/>	Titanium clear powdercoated	(not with 22" wheels)	
AGN070207	<input type="checkbox"/>	Supergrip		
AGN070208	<input type="checkbox"/>	Max Grepp	(only 22", 24" wheels)	
AGN070212	<input type="checkbox"/>	Handrims, Ellipse 3R, black	(ergonomic handrims with rubber-strip; only 24" and 25")	
AGN070250	<input type="checkbox"/>	Handrim cover	(only 22" & 24" wheels)	
Handrim mounting	AGN070317	● Close = 17mm	(12,5 mm with lightweight & Proton wheels)	
	AGN070327	○ Wide = 27mm	(not with lightweight & spinergy wheel and alu handrim)	
	AGN070307	□ Extra close = 7mm	(only with stainless steel)	

WHEEL CAMBER

(choose only one option)

AGN070600	<input checked="" type="radio"/>	0°		
AGN070603	<input type="radio"/>	3°		
AGN070606	<input type="radio"/>	6°		
AGN070609	<input type="radio"/>	9°	(not with handbike axle)	

SPOKE GUARDS (only available in 22" & 24")

AGN070831	<input type="checkbox"/>	Transparent		
		AGN070813	<input type="checkbox"/>	Galactica
AGN070823	<input type="checkbox"/>	Princess	AGN070818	<input type="checkbox"/>
				Jungle Fever
AGN070816	<input type="checkbox"/>	Happy Lions		
AGN070819	<input type="checkbox"/>	Monkeys	AGN070821	<input type="checkbox"/>
				Pirates
			AGN070811	<input type="checkbox"/>
				Feather
AGN070820	<input type="checkbox"/>	Oriental		
AGN070829	<input type="checkbox"/>	Superhero	AGN070814	<input type="checkbox"/>
				Graffiti
			AGN070806	<input type="checkbox"/>
				Chrome wheel
AGN070817	<input type="checkbox"/>	Hot wheels	AGN070802	<input type="checkbox"/>
				Basketball
			AGN070803	<input type="checkbox"/>
				Basketball 2
AGN070822	<input type="checkbox"/>	Pool	AGN070812	<input type="checkbox"/>
				Flying water
			AGN070828	<input type="checkbox"/>
				Space
AGN070827	<input type="checkbox"/>	Silk		
AGN070830	<input type="checkbox"/>	Tiger	AGN070833	<input type="checkbox"/>
				Zebra

WHEEL LOCKS (Choose only one option)

AGN060001	<input checked="" type="radio"/>	Standard wheel lock		
AGN060002	<input type="checkbox"/>	Knee lever wheel lock		
AGN060003	<input type="checkbox"/>	Compact wheel lock EVO	(only with 0°/3° camber)	
AGN060010	<input type="checkbox"/>	Wheel lock extension knee lever brake lock	(only on knee lever wheel lock)	
AGN060006	<input type="checkbox"/>	One arm wheel lock left	(only with 0°/3° camber)	
AGN060007	<input type="checkbox"/>	One arm wheel lock right	(only with 0°/3° camber)	

ACCESSORIES

AGN090000	<input checked="" type="radio"/>	Tool kit		
AGN090024	<input type="checkbox"/>	High pressure pump		
AGN090025	<input type="checkbox"/>	Air pump		
AGN090030	<input type="checkbox"/>	Back pack		
AGN090100	<input type="checkbox"/>	Crash Test Option (2)		
AGN090026	<input type="checkbox"/>	Mobile phone pocket		

(1) Not available mounting wide with Lightweight & Proton wheels

(2) Max. user weight 136kg

For more information
visit our webpage

www.SunriseMedical.eu



AGN070208
Max Grepp



AGN070207
Supergrip



AGN070212
Ellipse 3R



AGN060001
Standard Wheel lock



AGN060003
Compact wheel lock



AGN060002
Knee lever wheel lock



AGN060007
One arm wheel lock
right



AGN090000
Tool kit



AGN090024
High pressure pump



AGN090025
Air pump



AGN090030
Back pack



AGN090026
Mobile phone pocket

Quickie Argon²

● = Standard ○ = No cost option □ = Cost option

COLOURS Please consult our colour catalogue, to review your colour choice at the end of the order form

	Frame	Handrim	Hub/rim		Frame	Handrim	Hub/rim
02 Brilliant Silver	○	□	□	27 Graphitemetallic	○	□	□
03 Silver Matt	□	□	□	29 Black	○	□	□
06 Sun Yellow	○	□	□	31 Matt Black	○	□	□
14 Blue	○	□	□	32 Signal White	○	□	□
15 Brilliant Marine	○	□	□	33 Pink	○	□	□
16 Matt Marine	□	□	□	34 Dark Chocolate Meta	□	□	□
19 Brilliant Purple	○	□	□	35 Skyblue	□	□	□
21 Red Ruby	○	□	□	36 Cyan-Metallic	□	□	□
22 Brilliant Red	□	□	□	37 Marsred (Orange)	□	□	□
23 Matt Red	□	□	□	40 Kiwi	□	□	□
24 Tutti Frutti Orange	○	□	□	41 Flamingo-Glitter	□	□	□
				42 Matt-Anthracite	○	□	□
				46 Mamba Green (new)	□	□	□

Style Package (Colours for Carbotecture Forks)

- AGN100502 ● Black
 AGN100503 □ Silver
 AGN100501 □ Orange

(1) only with universal cross spoked rear wheels

Comments for special build:

Examples of available build 4 me options

- Abduction frame (2389)
- One arm drive (2437)
- Headrest (2398)
- SW 520 mm (2365)
- Drumbrake (2381)
- Footplate flip back (2949)
- Low front seat height (420 - 430 mm with 3" castor)

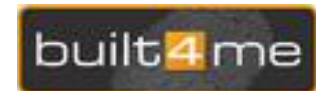

Argon² - Base Price

Option price

Packaging and transport

Exclusive VAT

VAT.

Total Price

Sunrise Medical Customer service
 Address: Kahlbachring 2-4, D-69254 Malsch/Heidelberg
 Tel. +497253 980-0
 Fax. +497253 980-222

E-mail: export@sunrisemedical.de
 Website: www.sunrisemedical.eu

