

## Fitting / Order form

Prices valid from: dd-mm-yyyy

### Dealer information

Customer (name / code)	/
Contact	
Address	
Post code / City	/
Phone / Fax	/

### Delivery address

Name	/
Address	
Post code / City	/
Phone	
E-mail	
Your reference	
Your order number	

## TiLite ZRA



- Required choice
- /  Optional choice
- /  Default required option

### Fitting date

### User weight

Fitting date (dd-mm-yyyy)		kg
---------------------------	--	----

code	Price
	excl VAT incl VAT

### FRAME STYLE

- |        |                          |  |         |
|--------|--------------------------|--|---------|
| Z2FS2  | <input type="checkbox"/> | <b>TILITE ZRA SERIES 2</b><br><i>(Full Adjustability. 265 Pound (120 kg) Weight Limit. 150 Pound (68 kg) Weight Limit for Rear Seat Width A and Seat Depth B of 10"x10" to 1;</i>  | 3285,00 |
| Z2HDR1 | <input type="checkbox"/> | <b>FRAME, HEAVY DUTY</b><br><i>(300 Pound (136 kg) Weight Limit. No charge when 20" Rear Seat Width A and 20" Seat Depth B are selected. Includes Tension Adjustable by Straps Back Upholstery. Requires Folding Aluminum Adjustable Height Backrest, Billet Aluminum Front Wheels, Shadow or Spinergy SPOX Rear Wheels. LX Rear Wheels only available with 0 or 2 degree camber. Not available with Slipstream Fork, Velcro Adjustable Upholstery, Swing Away Tubular Armrest or Swing Away Flip Back Tubular Armrest.)</i> | 0,00    |
| Z2RFR1 | <input type="checkbox"/> | <b>FRAME, REINFORCED</b><br><i>(No charge when 20" Rear Seat Width and 20" Seat Depth or Heavy Duty is selected.)</i>  | 0,00    |

### LANGUAGE USER MANUAL

Language	Choose	▼		
----------	--------	---	--	--

### TRANSPORT OPTIONS

- |       |                          |  |        |
|-------|--------------------------|--|--------|
| Z2WTB | <input type="checkbox"/> | <b>TRANSPORT BRACKETS</b><br><i>(Consists of four Tie-Down Brackets. Unoccupied use only. Please refer to the ZR Transport Bracket Supplement for important information regarding the Transit Options)</i> | 313,00 |
|-------|--------------------------|--|--------|

### FRAME FINISHES

- |         |                          |   |        |
|---------|--------------------------|---|--------|
| Z2FF1   | <input type="checkbox"/> | <b>TITANIUM - SATIN FINISH</b><br><i>(Available with Titanium Frame only.)</i>  | 0,00   |
| Z2SCBT1 | <input type="checkbox"/> | <b>BUFFING PADS SATIN FINISH</b>  |        |
| Z2FF3   | <input type="checkbox"/> | <b>TATTOO ON TITANIUM AND ALUMINIUM FRAME</b><br><i>(Tattoos on front frame tubes. Titanium frame finished in Satin. Aluminum frame is tattooed on blasted aluminum with a clear coat. Tattoos will be trimmed and adjusted to fit your frame.)</i> | 313,00 |
| Z2FF44  | <input type="checkbox"/> | <b>TATTOO FLOWER GARDEN</b>   | 0,00   |
| Z2FF45  | <input type="checkbox"/> | <b>TATTOO NEED FOR SPEED</b>  | 0,00   |
| Z2FF43  | <input type="checkbox"/> | <b>TATTOO MOSAIC</b>  | 0,00   |



### COLOR

- |   |  |   |
|---|--|---|
| <input type="checkbox"/> Z2FF61 SEAFOAM GREEN   | <input type="checkbox"/> Z2FF62 BLUE MIST  | <input type="checkbox"/> Z2FF63 LAVENDER DUSK |
| <input type="checkbox"/> Z2FF8 HIGH GLOSS BLACK | <input type="checkbox"/> Z2FF10 RED PEPPER | <input type="checkbox"/> Z2FF29 NEON PINK     |

- |   |  |   |
|---|--|---|
| <input type="checkbox"/> Z2FF14 OCEAN BLUE METALLIC | <input type="checkbox"/> Z2FF15 TANGERINE METALLIC | <input type="checkbox"/> Z2FF30 ACID GREEN METALLIC |
| <input type="checkbox"/> Z2FF17 MIDNIGHT BLUE PEARL | <input type="checkbox"/> Z2FF18 WHITE PEARL        | <input type="checkbox"/> Z2FF59 POMEGRANITE RED     |
| <input type="checkbox"/> Z2FF19 BLACK LAVA          | <input type="checkbox"/> Z2FF27 TITANIUM GRAY      | <input type="checkbox"/> Z2FF60 SILVER STREAK       |
| <input type="checkbox"/> Z2FF57 INDIGO PURPLE       | <input type="checkbox"/> Z2FF58 BLACK GALAXY       | <input type="checkbox"/> Z2FF64 DAFFODIL YELLOW     |
| <input type="checkbox"/> Z2FF40 HYPER BLUE          | <input type="checkbox"/> Z2FF41 FLAME ORANGE       | <input type="checkbox"/> Z2FF42 OD GREEN            |

**COLOR ANODIZE PACKAGE**

(Color Anodize Package includes: Caster Mount, Caster Fork, and Caster Caps. If no anodize color is selected, the default will be black.)

- |         |   |       |
|---------|---|-------|
| Z2ANO1  | <input checked="" type="radio"/> COLOR ANODIZE PACKAGE- BLACK | 0,00  |
| Z2ANO12 | <input type="radio"/> COLOR ANODIZE PACKAGE- GOLD             | 49,00 |
| Z2ANO15 | <input type="radio"/> COLOR ANODIZE PACKAGE- GREEN            | 49,00 |
| Z2ANO13 | <input type="radio"/> COLOR ANODIZE PACKAGE- PURPLE           | 49,00 |
| Z2ANO14 | <input type="radio"/> COLOR ANODIZE PACKAGE- ORANGE           | 49,00 |
| Z2ANO10 | <input type="radio"/> COLOR ANODIZE PACKAGE- BLUE             | 48,00 |
| Z2ANO11 | <input type="radio"/> COLOR ANODIZE PACKAGE- RED              | 49,00 |

**TiFit: TAILORED INDIVIDUALIZED FRAME**

**REAR SEAT WIDTH (A)**

Measure from outside of seat tube at back post to the outside of the opposite seat tube at back post to the outside of the opposite seat tube at back post.

- |           |  |   |        |
|-----------|--|---|--------|
| Z2RSW4-10 | <input type="checkbox"/> REAR SEAT WIDTH 10" | <input type="checkbox"/> 11" <input type="checkbox"/> 12" <input type="checkbox"/> 13" <input type="checkbox"/> 14" | 0,00   |
|           |  | <input type="checkbox"/> 16" <input type="checkbox"/> 17" <input type="checkbox"/> 18" <input type="checkbox"/> 19" |        |
| Z2RSW2    | <input type="checkbox"/> REAR SEAT WIDTH 20" |   | 447,00 |

**FRONT SEAT WIDTH (SEAT TAPER) (T)**

Measure from inside of front frame tube to inside of opposite front frame tube. (Required with V-Front End (V). Not Available with Standard Front End (I))

- |        |   |        |
|--------|---|--------|
| Z2FSW1 | <input type="checkbox"/> FRONT SEAT WIDTH WITH NOTAPER<br>(2.5" Narrower than Rear Seat Width A.)   | 0,00   |
| Z2FSW3 | <input type="checkbox"/> FRONT SEAT WIDTH WITH 1.5" TAPER<br>(4" Narrower than Rear Seat Width A. Includes Tension Adjustable by Straps Seat Upholstery.) Bolt On Adjustable Sling available through our Creative Mobility Division #20 | 254,00 |

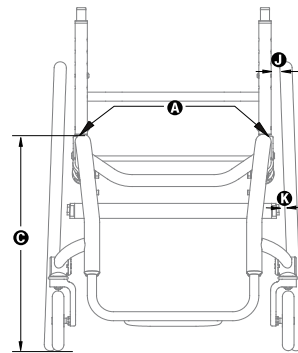

**SEAT DEPTH (B)**

Measure from front of back post to the front edge of seat sling. Frame bend will start .5" in front of seat sling unless Custom Frame Depth is specified, or the combination of specifications affect the rolling dynamics of the chair.

- |          |  |   |        |
|----------|--|---|--------|
| Z2SD1-10 | <input type="checkbox"/> SEAT DEPTH 10"  | <input type="checkbox"/> 11" <input type="checkbox"/> 12" <input type="checkbox"/> 13" <input type="checkbox"/> 14" | 0,00   |
|          |  | <input type="checkbox"/> 16" <input type="checkbox"/> 17" <input type="checkbox"/> 18" <input type="checkbox"/> 19" |        |
| Z2SD2    | <input type="checkbox"/> SEAT DEPTH 20"<br>(Custom seat depth available through CMD) |   | 471,00 |

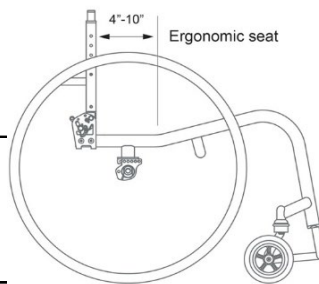

**ERGONOMIC SEAT (U)**

Measure from front of back post to beginning of upward bend of seat tube.

- |          |   |        |
|----------|---|--------|
| Z2ERG2-6 | <input type="checkbox"/> AERO T AND TRA ERGONOMICSEAT   | 372,00 |
|          | <input type="radio"/> 6" (B)=12"+ <input type="radio"/> 7" (B)=12"+ <input type="radio"/> 8" (B)=13"+ |        |

(Not available with V-Front or Seat Taper, Desk Arms, Depth Adjustable Backrests, Fold Down Rigid Sideguards, Fendered Adjustable Sideguards, Solid Seat.) Bolt On Adjustable Sling available through our Creative Mobility Division #20. Solid Seat available through Creative Mobility Division #16.)

**FRONT SEAT HEIGHT (C)**

Measure from floor to top of seat tube at front edge of seat sling

- |           |   |      |
|-----------|---|------|
| Z2FSH1-16 | <input type="radio"/> FRONT SEAT HIGHT 16" <input type="radio"/> 15.5" <input checked="" type="radio"/> 16" <input type="radio"/> 16.5" <input type="radio"/> 17" <input type="radio"/> 17.5" <input type="radio"/> 18" | 0,00 |
|           | <input type="radio"/> 18.5" <input type="radio"/> 19" <input type="radio"/> 19.5" <input type="radio"/> 20" <input type="radio"/> 20.5" <input type="radio"/> 21"   |      |

**REAR SEAT HEIGHT (D)**

Measure from floor to top of seat tube at back post.

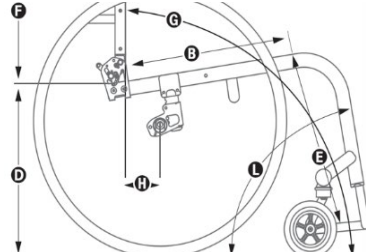

Z2RSH1-12.5	<input type="radio"/> 12.5" <input type="radio"/> 14.5" <input type="radio"/> 16.5" <input type="radio"/> 18.5" <input type="radio"/> 13" <input type="radio"/> 15" <input type="radio"/> 17." <input type="radio"/> 19" <input type="radio"/> 13.5" <input type="radio"/> 15.5" <input type="radio"/> 17.5" <input type="radio"/> 19.5" <input type="radio"/> 14" <input type="radio"/> 16" <input type="radio"/> 18." <input type="radio"/> 20"	<table border="1" style="width: 100%; border-collapse: collapse;"> <tr> <th>Rear wheel size</th> <th>Rear seat height</th> </tr> <tr> <td>20"</td> <td>12.5"-20"</td> </tr> <tr> <td>22"</td> <td>13.5"-20"</td> </tr> <tr> <td>24"</td> <td>14.5"-20"</td> </tr> <tr> <td>25"</td> <td>15.0"-20"</td> </tr> <tr> <td>26"</td> <td>15.5"-20"</td> </tr> </table>	Rear wheel size	Rear seat height	20"	12.5"-20"	22"	13.5"-20"	24"	14.5"-20"	25"	15.0"-20"	26"	15.5"-20"		0,00
Rear wheel size	Rear seat height															
20"	12.5"-20"															
22"	13.5"-20"															
24"	14.5"-20"															
25"	15.0"-20"															
26"	15.5"-20"															

**FRONT ANGLE or OVERALL FRAME LENGTH**

Select one. If Overall Frame Length is selected, front angle will be bent to achieve requested length.

Z2FA1-70	<input type="radio"/> FRONT ANGLE 70°	0,00
Z2FA1-75	<input type="radio"/> FRONT ANGLE 75°	0,00
Z2FA1-80	<input type="radio"/> FRONT ANGLE 80°	0,00
Z2FA1-85	<input type="radio"/> FRONT ANGLE 85° <i>(L) Measure from frame front to floor. (Not available with 6" Front Wheels.)</i>	0,00
Z2FA1-90	<input type="radio"/> FRONT ANGLE 90° <i>(Not available with 5" or 6" Front Wheels.)</i>	0,00
Z2FA2	<input type="radio"/> OVERALL FRAME LENGTH      M= <input style="width: 40px;" type="text"/> "	NCO
<i>Measure from front of backrest to Front Edge of Footrest.</i>		

**SEAT TO FOOTREST (E)**

Measure from front edge of seat sling to top rear of footrest.

STFR-xxx	<input type="checkbox"/> STANDARD FOOTREST Measurement must be at least 2" shorter than Front Seat Height (C).	0,00												
	<table border="1" style="width: 100%; border-collapse: collapse;"> <tr> <td><input type="radio"/> 13.5"</td> <td><input type="radio"/> 15"</td> <td><input type="radio"/> 16.5"</td> <td><input type="radio"/> 18."</td> </tr> <tr> <td><input type="radio"/> 14"</td> <td><input type="radio"/> 15.5"</td> <td><input type="radio"/> 17."</td> <td><input type="radio"/> 18.5"</td> </tr> <tr> <td><input type="radio"/> 14.5"</td> <td><input type="radio"/> 16"</td> <td><input type="radio"/> 17.5"</td> <td><input type="radio"/> 19"</td> </tr> </table>	<input type="radio"/> 13.5"	<input type="radio"/> 15"	<input type="radio"/> 16.5"	<input type="radio"/> 18."	<input type="radio"/> 14"	<input type="radio"/> 15.5"	<input type="radio"/> 17."	<input type="radio"/> 18.5"	<input type="radio"/> 14.5"	<input type="radio"/> 16"	<input type="radio"/> 17.5"	<input type="radio"/> 19"	
<input type="radio"/> 13.5"	<input type="radio"/> 15"	<input type="radio"/> 16.5"	<input type="radio"/> 18."											
<input type="radio"/> 14"	<input type="radio"/> 15.5"	<input type="radio"/> 17."	<input type="radio"/> 18.5"											
<input type="radio"/> 14.5"	<input type="radio"/> 16"	<input type="radio"/> 17.5"	<input type="radio"/> 19"											
Z2FTR3	<input type="checkbox"/> FOOTREST ANGLE ADJUSTABLE	0,00												
Z2FTR1	<input type="checkbox"/> FOOTREST TITANIUM WITH FLAT ABS COVER	176,00												
Z2FTR2	<input type="checkbox"/> FOOTREST TITANIUM OPEN LOOP	237,00												
Z2FTR12	<input type="checkbox"/> FOOTREST FLIP-BACK <i>(Not available with 10" or 11" Rear Seat Width A or Heavy Duty Frame.)</i>	194,00												
STFR-xxx	<input type="checkbox"/> HIGH MOUNTED FOOTREST	0,00												
STFR-S	<input type="radio"/> 7" - 9"      Set at: <input style="width: 40px;" type="text"/> "													
STFR-M	<input type="radio"/> 9" - 11"     Set at: <input style="width: 40px;" type="text"/> "													
STFR-L	<input type="radio"/> 11" - 13"    Set at: <input style="width: 40px;" type="text"/> "													
Z2FTR4	<input type="checkbox"/> FOOTREST ANGLE ADJUSTABLE HIGH MOUNT	92,00												

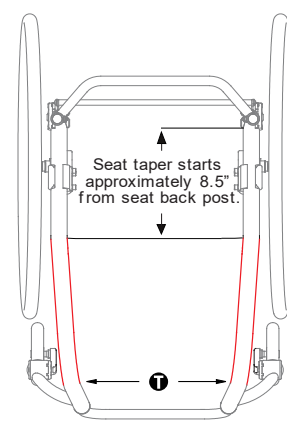

**FOOTREST WIDTH (I) or (V)**

Select either a Standard Front End (I) if no Seat Taper (T) is selected or a V-Front End (V) if a Seat Taper (T) is selected

**STANDARD FRONT END (I)**

Find your Rear Seat Width A in the Chart below and select one of the options to the right. Measure from inside of front frame tube to inside of opposite front frame tube. (Not available with Front Seat Width (Seat Taper) T.)

Z2FE1-0	<input type="checkbox"/> STANDARD FRONT END NO TAPER <i>(Required when both Heavy Duty Frame and Seat Taper T are selected.)</i>	0,00
---------	---	------

REAR SEAT WIDTH <i>(Outside measurement)</i>	No Taper <i>(2.5" Narrower than rear seat width)</i>	1.5" Taper <i>(4" Narrower than rear seat width)</i>	3.5" Taper <i>(6" Narrower than rear seat width)</i>
10	<input type="radio"/> 7.5"		
11"	<input type="radio"/> 8.5"		
12"	<input type="radio"/> 9.5"	<input type="radio"/> 8"	
13"	<input type="radio"/> 10.5"	<input type="radio"/> 9"	
14"	<input type="radio"/> 11.5"	<input type="radio"/> 10"	
15"	<input type="radio"/> 12.5"	<input type="radio"/> 11"	<input type="radio"/> 9"
16"	<input type="radio"/> 13.5"	<input type="radio"/> 12"	<input type="radio"/> 10"

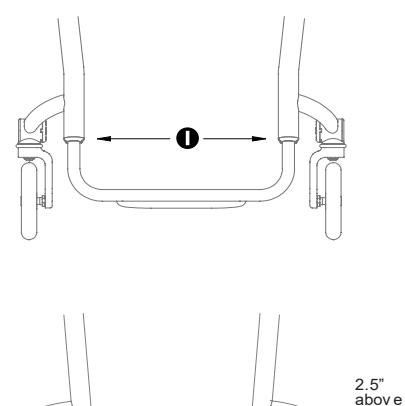

17"	<input type="radio"/>	14.5"	<input type="radio"/>	13"	<input type="radio"/>	11"
18"	<input type="radio"/>	15.5"	<input type="radio"/>	14"	<input type="radio"/>	12"
19"	<input type="radio"/>	16.5"	<input type="radio"/>	15"	<input type="radio"/>	13"
20"	<input type="radio"/>	17.5"	<input type="radio"/>	16"	<input type="radio"/>	14"

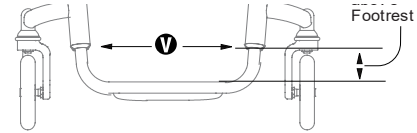

**V-FRONT END (V)**

Measure from inside of front frame tube to inside of opposite front frame tube 2-1/2" above footrest. (Required with Front Seat Taper T. Titanium Footrests have 1" of adjustment up and down. Not available with Ergonomic Seat frames.)

Z2FE2-9	<input type="checkbox"/>	FOOTREST FRONT END WIDTH--V 9"	104,00
	<input type="checkbox"/>	10"	
	<input type="checkbox"/>	11"	
	<input type="checkbox"/>	12"	
	<input type="checkbox"/>	13"	
	<input type="checkbox"/>	14"	
	<input type="checkbox"/>	15"	

**BACKREST UPHOLSTERY**

(Want more seating options? Click here to view the new TiLite Seating Order Form.)

Z2BUP2	<input type="checkbox"/>	BACK UPHOLSTERY VELCRO ADJUSTABLE <i>(Not available with Fold-Down Push Handles.)</i>	0,00
--------	--------------------------	--	------

**Tension Adjustable by Straps**

(Required with Fold-Down Push Handles.)

Z2BUP3	<input type="checkbox"/>	BACK UPHOLSTERY STRAPS TENSION ADJUSTABLE	100,00
Z2BUP5	<input type="checkbox"/>	UPHOLSTERY AIR BREATHABLE <i>(Not available with Ultrasuede Backrest Stripe.)</i>	176,00
Z2UPC3-BL	<input type="checkbox"/>	UPHOLSTERY BACKREST STRIPE ULTRASUEDE BLACK	95,00
Z2BUP0	<input type="checkbox"/>	WITHOUT BACK UPHOLSTERY	0,00

**SEAT BACK TYPE/PUSH HANDLES/SEAT BACK HEIGHT (F)**

Measure from top of back post to top of seat tube at rear of frame.

Z2SB1	<input type="checkbox"/>	FOLDING ALUMINUM ADJUSTABLE HEIGHT SEAT BACK <i>(Required for Heavy Duty Frame.)</i>	0,00
Z2SB2	<input type="checkbox"/>	FOLDING TITANIUM ADJUSTABLE HEIGHT <i>(Titanium back will match Frame Finish. Not available with Bolt-On Push Handles.)</i>	176,00
Z2SB15	<input type="checkbox"/>	SEAT BACK, NON-FOLDING, FIXED-HEIGHT TITANIUM <i>(Titanium back will match Frame Finish. Not available with Push Handles.)</i>	254,00

**TISHAFT™ BACK RELEASE BARS**

(Not available with Non-Folding, Fixed Height Titanium Back.)

Z2SB3	<input type="checkbox"/>	BACK RELEASE BAR ALUMINUM TISHAFT	0,00
Z2SB5	<input type="checkbox"/>	BACK RELEASE BAR CARBON FIBER TISHAFT	63,00

**PUSH HANDLES (select above)**

Z2SB6	<input type="checkbox"/>	PUSH HANDLES INTEGRATED	0,00
Z2SB7	<input type="checkbox"/>	PUSH HANDLES INTEGRATED FOLD-DOWN <i>(Requires Tension Adjustable by Straps Back Upholstery.)</i>	104,00
Z2SB8	<input type="checkbox"/>	PUSH HANDLES BOLT-ON <i>(Includes 4" Deep Backrest Rigidizer Bar. Not available with Ti Back.)</i>	176,00
Z2SB9	<input type="checkbox"/>	PUSH HANDLES BOLT-ON HEIGHT ADJUSTABLE <i>(Includes 4" Deep Backrest Rigidizer Bar. Not available with Ti Back.)</i>	303,00

**FOLDING SEAT BACK HEIGHT (F) (Z2SB1 and Z2SB2)**

PUSH HANDLES (select above)	Short	Medium	Tall	use 0.5" increments
None/Bolt on	9.5"-12.5"	13.5"-17.5"	17"-21.5"	Set at:
Integrated	11.5"-13.5"	14.5"-17.5"	18.5"-21.5"	Set at:
Intergated fold down	14"-16.5"	15"-19.5"	19.5"-22"	Set at:

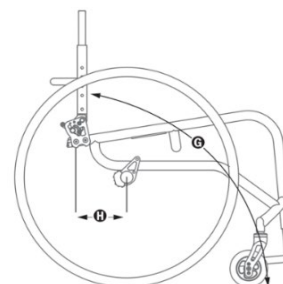

**NON-FOLDING, FIXED-HEIGHT (F) TITANIUM SEAT BACK**

with New Rounded Rigidizer Bar

(Titanium back will match Frame Finish. Required for fixed Side Guards. Not available with Swing Away Tubular or Swing Away - Flip Back Tubular Armrests and Integrated Push Handles, Integrated Fold-Down Push Handles or Bolt-On Height Adjustable Push Handles.)

Height 8" to 20" in 0.5" steps

Set at: "

**AVAILABLE ON ALL BACKS**

- Z2SB11  BACKREST THAT LOCKS IN FOLDED POSITION 0,00  
*(Not available with Ergonomic Seat.)*
- Z2SB19  4" DEEP BACKREST RIGIDIZER BAR 0,00  
*(Required with Heavy Duty Frame. Not available with a Non-Folding, Fixed Height Titanium Seat Back Type. 4" Deep Rigidizer Bar is NOT a rounded style rigidizer bar.)*
- Z2SB16  BACK/FRAME DEPTH ADJUSTABLE 184,00  
*(Seat Depths B of 10"-18" allow 2" of rearward adjustment. Height Adjustable Push Handles have a limited height range with Depth Adjustable Back. Not Available with 19" or 20" Seat Depths B, Heavy Duty Frame, Tension Adjustable By Straps Seat Upholstery or Carbon Fiber Side Guards.)*

**SEAT BACK ANGLE (G)**

Measure angle from front of back post to floor.

- Z2SBA3-80 

SEAT BACK ANGLE FOR NON-FOLDING BACK 80° 0,00  
 83°     89°     95°     101°  
 86°     92°     98°
- Z2SBA3-80 

SEAT BACK ANGLE FOR NON-FOLDING BACK 80° 0,00  
 81°     85°     89°     93°     97°     101°  
 82°     86°     90°     94°     98°  
 83°     87°     91°     95°     99°  
 84°     88°     92°     96°     100°

**CENTER OF GRAVITY (H)**

Measure from front of back post at the seat tube to the center of the rear axle. If no center of gravity is selected, chair will ship with the center of gravity in the rearward-most position.

- Z2COG1-0 

CENTER OF GRAVITY 0" 0,00  
 1.25"     2.25"     3.25"     4.25"  
 1.5"     2.5"     3.5"     4.5"  
 1.75"     2.75"     3.75"     4.75"  
 2"     3"     4"     5"

**REAR WHEEL SPACING (J) / PLUGS**

Measure from outside of seat back post to inside of rear tire. TRA 0.75" Rear Wheel Spacing not available with 0° or 2° Camber K. Ergonomic Seat selection may limit available center of gravity.

- Z2RWS1-0.75 

REAR WHEEL SPACING 0.75"     1"     1.25" 0,00
- Z2CBR12  CAMBER PLUGS - ADJ REAR WHEEL 0,00
- Z2CBR9  SPACERS TO INCREASE REARWHEEL SPACING, ADDITIONAL 0,00
- Z2CBR11  CAMBER PLUGS 2°, 4°, OR 6° ZERO PLAY ALUMINUM 0,00  
*(Not available with Power Adaptable Frame or more than 6° of Camber K.)*

**SEAT UPHOLSTERY**

- Z2SUP1  TENSION ADJ. BOLT ON SEAT UPHOLST. W/ PHONE SLEEVE 0,00  
*(Not available with 10" or 11" Rear Seat Width A)*
- Z2SUP2  TENSION ADJUSTABLE BY STRAPS SEAT UPHOLSTERY 191,00  
*(Not available with 10" or 11" Rear Seat Width A or Ergonomic Seat)*
- Z2SUP8  SOLID SEAT, ALUMINUM 254,00

(Not available with 10" or 11" Rear Seat Width A or Ergonomic Seat)

Z2SUP0  WITHOUT SEAT UPHOLSTERY 0,00

**CAMBER (K) / CAMBER TUBES**

Z2CBR1-0  0° CAMBER  2°  4°  6° 0,00  
 (More than 0° of Camber K is not available with the Power Adaptable Frame. 8° of Camber may be available through our Creative Mobility Division.)

Z2CBR15  CAMBER TUBE ALUMINIUM 0,00

Z2CBR3  CAMBER TUBE TITANIUM 176,00  
 (Not available with Power Adaptable Frame.)

**CUSTOM CONFIGURATION OPTIONS**

**FRONT WHEELS**

Z2FW24  3"X1.4" LITESPEED-7 BILLETALU WHEEL W/SOFT ROLLTIRE 165,00  
 SILVER HUB  BLACK HUB

Z2FW14  4"X.75" PLASTIC WHEEL W/POLY TIRE 0,00  
 (Not available with Slipstream Fork or Power Adaptable Frame.)

Z2FW3  4"X.75" LIGHT-UP MICRO-CASTER 74,00  
 (Not available with Slipstream Fork or Power Adaptable Frame.)

Z2FW26  4"X1.4" LITESPEED-7 PLASTIC WHEEL W/SOFT ROLL TIRE 95,00  
 (Not available with Power Assist, Power Add-on System or Heavy Duty Frame.)

Z2FW27  4"X1.4" LITESPEED-7 BILLETALU WHEEL W/SOFT ROLLTIRE 165,00  
 SILVER HUB  BLACK HUB

Z2FW6  5"X1" PLASTIC WHEEL W/POLY TIRE 0,00  
 (Not available with 90° Front Angle L, Slipstream Fork or Power Adaptable Frame.)

Z2FW28  5"X1.4" LITESPEED-7 PLASTIC WHEEL W/SOFT ROLL TIRE 95,00  
 (Not available with 90° Front Angle L or Power Adaptable Frame.)

Z2FW30  5"X1.4" LITESPEED-7 BILLETALU WHEEL W/SOFT ROLLTIRE 165,00  
 SILVER HUB  BLACK HUB  
 (Not available with 90° Front Angle L.)

Z2FW9  6"X1" PLASTIC WHEEL W/POLY TIRE 0,00  
 (Not available with 85° or 90° Front Angle L, Slipstream Fork or Power Adaptable Frame.)

Z2FW32  6"X1.4" LITESPEED-7 PLASTIC WHEEL W/SOFT ROLL TIRE 95,00  
 (Not available with 85° or 90° Front Angle L, Slipstream Fork or Power Adaptable Frame.)

Z2FW33  6"X1.4" LITESPEED-7 BILLETALU WHEEL W/SOFT ROLLTIRE 165,00  
 SILVER HUB  BLACK HUB  
 (Not available with 85° or 90° Front Angle L.)

**PRECISION LOCK FRONT FORKS**

Z2FK1  FORK, STANDARD TILITE 0,00

Z2FK2  FORK, SLIPSTREAM SINGLE-SIDED TILITE 176,00  
 (Not available with Heavy Duty Frame or Power Adaptable Frame.)

Z2GL1  OUT-FRONT GLIDE® SUSPENSION FORKS 435,00  
 USER WEIGHT  > 56kg  56kg-81kg  81kg-120kg  
 (Black anodize only.)

Z2TS1  FORK STEMS TITANIUM 48,00

**STANDARD REAR WHEELS**

Z2RW14-20  WHEELS REAR 20" TILITE SHADOW  22"  24"  25"  26" 0,00  
 25" and 26" require 15" minimum Seat depth (B)

**PERFORMANCE REAR WHEELS**

(See Rear Seat Height Ranges Chart for Rear Seat Height D limitations.)

Z2RW7-22  WHEELS REAR SPINERGY SPOX 22"  24"  25"  26" 495,00  
 Spinergy SPOX  RED  BLACK  BLUE  WHITE

25" and 26" require 15" minimum Seat depth (B)		
Z2RW8-22	<input type="radio"/> WHEELS REAR SPINERGY LX 22" 25" and 26" require 15" minimum Seat depth (B) <input type="radio"/> 24" <input type="radio"/> 25" <input type="radio"/> 26"	695,00
	<input type="radio"/> BLACK <input type="radio"/> RED <input type="radio"/> BLUE <input type="radio"/> WHITE <input type="radio"/> BRIGHT ORANGE <input type="radio"/> FLAMINGO PINK <input type="radio"/> PURPLE	
Z2RW9-22	<input type="radio"/> 22" (501) SPINERGY DESIGN LAB LX 25" and 26" require 15" minimum Seat depth (B) <input type="radio"/> 24" <input type="radio"/> 25" <input type="radio"/> 26"	695,00
	<input type="radio"/> BLACK <input type="radio"/> RED <input type="radio"/> BLUE <input type="radio"/> WHITE <input type="radio"/> BRIGHT ORANGE <input type="radio"/> FLAMINGO PINK <input type="radio"/> PURPLE (If same color is selected, anodized hubs and rims match color anodized package on page 1. Available with black spokes only.)	
Z2RW16-24	<input type="radio"/> WHEELS REAR 24" CARBON BLADE (Not available with Heavy Duty Frame, 25" requires 15" minimum Seat depth (B)) <input type="radio"/> 25"	1150,00
Z2RW17-20	<input type="radio"/> WHEELS REAR 20" SKYWAY® MAGS (Not available with Heavy Duty Frame, Short Tabs, Quad Release Axles, Spoke Guards or Omit Handrims Option. Requires Aluminum Sliver Anodized Handrims.) <input type="radio"/> 22" <input type="radio"/> 24"	100,00
<b>AXLES</b>		
Z2AXL1	<input type="checkbox"/> AXLE QUICK RELEASE STAINLESS	0,00
Z2AXL2	<input type="checkbox"/> AXLE QUICK RELEASE TITANIUM	237,00
Z2AXL3	<input type="checkbox"/> AXLE QUAD RELEASE (Not available with Mag or 26"(590) Spinergy Spox or LX Rear Wheels.)	139,00
<b>PNEUMATIC REAR TIRES</b>		
Z2RTR1	<input type="checkbox"/> TIRES REAR 20", 22", 24"OR 26" TREADED	0,00
Z2RTR2	<input type="checkbox"/> TIRES REAR 20",22",24",26" TREADED, AIRLESS INSERT (Not available with Spinergy Carbon Blade Rear Wheels.)	85,00
Z2RTR31	<input type="checkbox"/> MBL SPEEDLITE (PNEUMATIC)	0,00
Z2RTR30	<input type="checkbox"/> TIRES REAR 24",25" OR 26" PRIMO SENTINEL PNEUMATIC	95,00
Z2RTR8	<input type="checkbox"/> TIRES REAR 24" 25"OR 26"SCHWALBE MARATHON+ EVOL.	95,00
Z2RTR24	<input type="checkbox"/> TIRES REAR, KENDA KOBRA KNOBBY	95,00
<b>SOLID REAR TIRES</b>		
(Not available with Spinergy Carbon Blade Rear Wheels.)		
Z2RTR22	<input type="checkbox"/> TIRES REAR, SOLID, PRIMOEXPRESS	95,00
Z2RTR23	<input type="checkbox"/> TIRES REAR, SOLID, PRIMOACTIVE	95,00
<b>HANDRIMS</b>		
<b>Handrims by OUT-FRONT®</b>		
Z2RIM1	<input type="checkbox"/> ALUMINUM- SILVER ANODIZED	0,00
Z2RIM21	<input type="checkbox"/> ALUMINUM- BLACK ANODIZED (Not available with 20"(451) Rear Wheels.)	49,00
Z2RIM12	<input type="checkbox"/> TITANIUM- SATIN FINISH (Not available with 20"(451) or 22"(501) Rear Wheels, or 24"(540) Knobby tires.)	290,00
Z2RIM10	<input type="checkbox"/> THE SURGE™ BY OUT-FRONT,ALL-IN-1 OVAL, L PROFILE (Not available with 20"(451) Rear Wheels.)	290,00
Z2RIM11	<input type="checkbox"/> THE SURGE™ LT BY OUT-FRONT ALL-IN-1 OVAL S PROFILE (Not available with 20"(451) Rear Wheels.)	290,00
Z2RIM20	<input type="checkbox"/> Q-GRIP (TETRA GRIPP BY TETRA EQUIPMENT) (Not available with 20"(451)Rear Wheels.)	290,00

**The Natural-Fit® (Original, Larger Profile)**

(Not available with 20"(451) Rear Wheels.)

Z2RIM14	<input type="checkbox"/>	NATURAL-FIT® BY OUT-FRONT - STANDARD GRIP <i>(Not available with Short Tabs or Spinergy Carbon Blade Rear Wheels)</i>	290,00
Z2RIM15	<input type="checkbox"/>	NATURAL-FIT® BY OUT-FRONT - SUPER GRIP <i>(Not available with Short Tabs or Spinergy Carbon Blade Rear Wheels.)</i>	290,00
Z2RIM16	<input type="checkbox"/>	NATURAL-FIT® BY OUT-FRONT - WITHOUT THUMB GRIP	290,00

**The Natural-Fit® LT (Reduced Weight, Smaller Profile)**

*(Not available with 20"(451) Rear Wheels.)*

Z2RIM17	<input type="checkbox"/>	NATURAL-FIT® LT BY OUT-FRONT - STANDARD GRIP <i>(Not available with Short Tabs or Spinergy Carbon Blade Rear Wheels.)</i>	290,00
Z2RIM18	<input type="checkbox"/>	NATURAL-FIT® LT BY OUT-FRONT - SUPER GRIP <i>(Not available with Short Tabs or Spinergy Carbon Blade Rear Wheels.)</i>	290,00
Z2RIM19	<input type="checkbox"/>	NATURAL-FIT® LT BY OUT-FRONT - WITHOUT THUMB GRIP	290,00

**Additional handrim options**

Z2RIM5	<input type="checkbox"/>	PLASTIC COATED- BLACK	117,00
--------	--------------------------	-----------------------	--------

**Tab length**

Z2RIM7	<input type="checkbox"/>	HANDRIM TAB LENGTH- LONGTABS	0,00
Z2RIM8	<input type="checkbox"/>	HANDRIM TAB LENGTH- SHORT TABS <i>(Not available with Mag Rear Wheels or The Natural-Fit® Handrims with Thumb Grip.)</i>	19,00

**WHEEL LOCKS**

**Wheel locks by OUT FRONT**

Z2WLK7	<input type="checkbox"/>	COMPACT COMPOSITE PUSH TO LOCK WHEEL BY OUT-FRONT <i>(Available with .75" to 1.5" Rear Wheel Spacing J only.)</i>	0,00
Z2WLK8	<input type="checkbox"/>	COMPACT COMPOSITE PULL TO LOCK WHEEL BY OUT-FRONT <i>(Available with .75" to 1.5" Rear Wheel Spacing J only.)</i>	0,00
Z2WLK10	<input type="checkbox"/>	EXTENSION HANDLES FOR COMPACT COMPOSITE PUSH/PULL	80,00

**Additional wheel locks**

Z2WLK11	<input type="checkbox"/>	MBL COMPOSITE SCISSOR LOCK	132,00
Z2WLK3	<input type="checkbox"/>	WHEEL LOCK UNI-LOCK <input type="checkbox"/> Push <input type="checkbox"/> Pull	148,00
Z2WLK4	<input type="checkbox"/>	EXTENSION HANDLES FOR UNI-LOCK	80,00
Z2WLK15	<input type="checkbox"/>	GRADE AIDS PUSH TO LOCK <i>(Not available with solid rear tires)</i>	164,00

**SIDE GUARDS**

**Aluminium**

Z2SDG2-S	<input type="checkbox"/>	SIDE GUARDS ALUMINUM, RIGID, REMOVABLE, SMALL <input type="checkbox"/> Small <input type="checkbox"/> Std	176,00
Z2SDG3-S	<input type="checkbox"/>	SIDE GUARDS ALU, QUAD REMOVABLE W/ HOLE SMALL <input type="checkbox"/> Small <input type="checkbox"/> Std	184,00
Z2SDG4-S	<input type="checkbox"/>	SIDE GUARDS ALUMINUM, FOLD DOWN RIGID, SMALL <input type="checkbox"/> Small <input type="checkbox"/> Std <i>(Not available with Ergonomic Seat.)</i>	303,00
Z2SDG6	<input type="checkbox"/>	SIDE GUARDS ALUMINUM, FENDERED ADJUSTABLE <i>(Available with 24" and 25" Rear Wheels. Requires Rear Seat Height D of 14.5" to 18.5".)</i>	303,00

**New 3k Weave Carbon Fiber**

Z2SDG7-S	<input type="checkbox"/>	SIDE GUARDS CARBON FIBER, RIGID REMOVABLE SMALL <input type="checkbox"/> Small <input type="checkbox"/> Large	276,00
Z2SDG8-S	<input type="checkbox"/>	SIDE GUARDS CARBON, QUADREMOVABLE WITH HOLE SMALL	284,00

	<input type="checkbox"/> Small	<input type="checkbox"/> Large	
Z2SDG9-S	<input type="checkbox"/>	SIDE GUARDS CARBON FIBER, FOLD DOWN RIGID, SMALL	412,00
	<input type="checkbox"/> Small	<input type="checkbox"/> Large	
		<i>(Not available with Ergonomic Seat or Carbon Edition.)</i>	
Z2SDG11	<input type="checkbox"/>	CARBON FIBER FENDERED ADJUSTABLE	362,00
		<i>(Available with 24" and 25" Rear Wheels. Requires Rear Seat Height D of 14.5" to 18.5")</i>	

**Available on Aluminum and Carbon Fiber Non-Fendered Side Guards**

Z2SDG13	<input type="checkbox"/>	SIDE GUARDS CUSTOM CUT TO PROFILE OF REAR WHEELS	280,00
---------	--------------------------	--	--------

**ARMRESTS**

(Desk Arms come with built-in Side Guards.)

**Tubular Armrests**

Z2ARM1-9	<input type="checkbox"/>	SWING AWAY TUBULAR 6.5"-9.5"	<input type="checkbox"/> 9.5"- 12.5"	194,00
		<i>(Not Available with Heavy Duty Frame or Height Adjustable Push Handles.)</i>		
Z2ARM4-9	<input type="checkbox"/>	SWING AWAY FLIP BACK TUBULAR 8.3"-11.5"		280,00
		<i>(Not Available with Heavy Duty Frame.)</i>		

**Single Post Desk Arms**

Z2ARM2-9-S	<input type="checkbox"/>	REMOV. ADJ. DESK ARM RIGID GUARD 9"-12"/S	<input type="checkbox"/> 12"-15"	303,00
	<input type="checkbox"/>	armrest pad length STD (10")	<input type="checkbox"/> Full length (12")	
		<i>(Requires 14" minimum Seat Depth B. Not available with Ergonomic Seat.)</i>		
Z2ARM3-9-S	<input type="checkbox"/>	REMOV. ADJ. DESK ARM RIGID GUARD+TRANSF. 9"-12"/S	<input type="checkbox"/> 12"-15"	331,00
	<input type="checkbox"/>	armrest pad length STD (10")	<input type="checkbox"/> Full length (12")	
		<i>(Requires 15" minimum Seat Depth B. Not Available with Ergonomic Seat.)</i>		

**Available Armrest Options**

Z2ARM5	<input type="checkbox"/>	ARMRESTS COVERED IN BLACK ULTRASUEDE		100,00
		<i>(Not available with Desk Arms)</i>		

**SEAT BELTS**

Z2BLT1	<input type="checkbox"/>	VELCRO ADJUSTABLE, BLACKNYLON WEBBING		40,00
Z2BLT2	<input type="checkbox"/>	BODYPOINT AUTO-STYLE RELEASE BUCKLE		92,00
Z2BLT4	<input type="checkbox"/>	BODYPOINT 1" PUSH-BUTTONBUCKLE PADDED -AUTO STYLE		167,00
		<i>(Not available with 19" or 20" Rear Seat Widths A.)</i>		
Z2BLT5	<input type="checkbox"/>	BODYPOINT 1.5" PUSH BUTTON BUCKLE PADDED AUTOSTYLE		167,00
		<i>(Not available with 19" or 20" Rear Seat Widths A.)</i>		
Z2BLT8	<input type="checkbox"/>	Q'STRAIT WC-19 WHEELCHAIR-ANCHORED PELVIC BELT		176,00
		<i>(Recommended for use with Transit Tie Down. Not Available with ZR.)</i>		
Z2BLT10	<input type="checkbox"/>	BODYPOINT OPTIONAL BAND CLAMP MOUNTING HARDWARE		19,00
Z2BLT16	<input type="checkbox"/>	BODYPOINT 1" WIDE EVOFLEX, PUSH-BUTTON BUCKLE		172,00

**CALFSTRAPS**

Z2CLF2-S	<input type="checkbox"/>	CALFSTRAP VELCRO ADJUSTABLE S		32,00
		<i>(Recommended for 9" - 12" Footrest Widths.)</i>		
Z2CLF2-M	<input type="checkbox"/>	CALFSTRAP VELCRO ADJUSTABLE M		32,00
		<i>(Recommended for 11" - 15" Footrest Widths.)</i>		
Z2CLF2-L	<input type="checkbox"/>	CALFSTRAP VELCRO ADJUSTABLE L		32,00
		<i>(Recommended for 14" - 17" Footrest Widths.)</i>		
Z2CLF2-XL	<input type="checkbox"/>	CALFSTRAP VELCRO ADJUSTABLE XL		32,00
		<i>(Recommended for 16" - 19" Footrest Widths.)</i>		
Z2CLF3-S	<input type="checkbox"/>	BODYPOINT PADDED VELCRO ADJUSTABLE S		95,00
		<i>(Recommended for 8" - 11" Footrest Widths.)</i>		
Z2CLF3-M	<input type="checkbox"/>	BODYPOINT PADDED VELCRO ADJUSTABLE M		95,00
		<i>(Recommended for 11" - 15" Footrest Widths.)</i>		

Z2CLF3-L	<input type="checkbox"/>	BODYPOINT PADDED VELCRO ADJUSTABLE L <i>(Recommended for 16" - 19" Footrest Widths.)</i>	95,00
Z2CLF1	<input type="checkbox"/>	BUCKLE ADJUSTABLE, BLACKNYLON WEBBING	22,00
<b>RESIDUAL LIMB SUPPORT</b>			
Z2RSL1-L	<input type="checkbox"/>	RESIDUAL LIMB SUPPORT, LEFT	318,00
Z2RSL1-R	<input type="checkbox"/>	RESIDUAL LIMB SUPPORT, RIGHT	318,00
Z2RSL2	<input type="checkbox"/>	RESIDUAL LIMB SUPPORT, PAIR	641,00
<b>BACKPACK</b>			
Z2BCK3	<input type="checkbox"/>	BACK PACK, BLACK NYLON	85,00
<b>SEAT POUCH</b>			
Z2PCH3	<input type="checkbox"/>	SEAT POUCH BLACK NYLON	49,00
Z2PCH5	<input type="checkbox"/>	BODYPOINT MOBILITY BAG	96,00
<b>SPOKE GUARDS</b>			
Z2GRD1	<input type="checkbox"/>	CLEAR LEXAN WITH TIMOTION LOGO <i>(Not available with Mag Rear Wheels.)</i>	117,00
<b>ANTI-TIP</b>			
Z2TIP1	<input type="checkbox"/>	ANTI TIP REAR ALUMINUM- BLACK	145,00
Z2TIP2	<input type="checkbox"/>	ANTI TIP REAR FLIP-UP USER FRIENDLY	298,00
<b>ACCESSORIES</b>			
Z2UEST1-12	<input type="checkbox"/>	UPPER EXTREMITY SUPPORT TRAY 12-14" <i>(Requires Armrests.)</i>	258,00
	<input type="checkbox"/>	13-15"	
Z2LUG1	<input type="checkbox"/>	LUGGAGE CARRIERS	132,00
Z2MPCT2-BL	<input type="checkbox"/>	IMPACT GUARDS NEOPRENE BLACK	95,00
Z2CH1	<input type="checkbox"/>	CRUTCH HOLDER	132,00