



**Customer Contact Details**

Customer Name: _____ Advisor: _____ Address: _____ _____ _____ Phone: _____ Email: _____	Ship to Customer Address: <input type="checkbox"/> Shipping Name: _____ Shipping Address: _____ _____ _____ Phone: _____ Email: _____
--	---

**Additional Information**

Notes: _____ _____ _____ _____	Current Wheelchair: _____ Customer Weight: _____ Customer Height: _____ Customer Disability: _____
---	---

**Other**

<p><u>VAT Exemption Declaration (UK Only):</u> I declare that I am chronically sick or disabled by reason of: _____ and that I am receiving from RGK Wheelchairs Ltd, the wheelchair specified herein and I claim relief from Value Added Tax under group 12 of schedule 8 to Value Added Tax Act 1994. Signature: _____ Date: _____</p>	<p><u>RGK Contact Authorisation:</u> From time to time, RGK would like to send you exclusive information, news and offers on everything RGK, by email or post. We will not pass any of your details to any third party. I would like to be contacted by RGK: <input type="checkbox"/> Signature: _____ Date: _____</p>
--	--

Guide:  Base product     Required option     Optional Extra    Critical Information    Information Needed

## PRODUCT STYLE

HLTXZ010 HI-LITE

XA070 Open design

XA080 Closed design

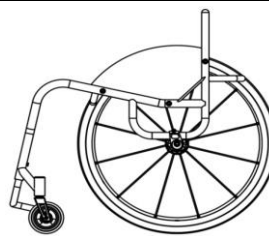

XA070 - Open design

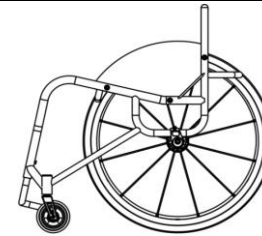

XA080 - Closed design

**Max User Weight 125kg (275lbs)**

**PLEASE NOTE: ALL RGK CHAIRS ARE HAND BUILT AND HAVE A MANUFACTURING MEASUREMENT TOLERANCE OF +/- 5MM**

## CAD APPROVAL

XW009 QUOTE ONLY (NO CAD FOR APPROVAL)

XW011 ORDER (NO CAD FOR APPROVAL)

XW012 QUOTE CAD drawing for approval  
(2 customer amendments ONLY)

XW010 ORDER CAD drawing for approval  
(2 customer amendments ONLY)

## KEY MEASUREMENTS

XY010 Seat width *(Inside to inside of sideguards)*

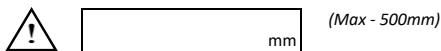

XY020 Seat length

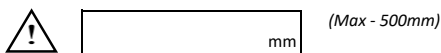

XY030 Extra Seat Length *(Provides additional leg support & hand grip)*

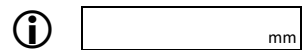

XY050 Front frame height

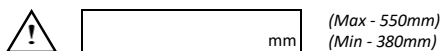

XY060 Rear frame height

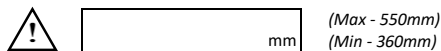

XY070 Frame length



XY072 Castor position

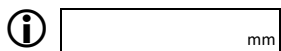

Optimise measurements

XA020 Ergonomic seat

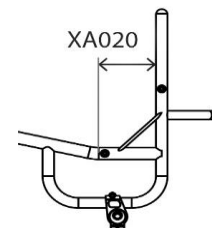
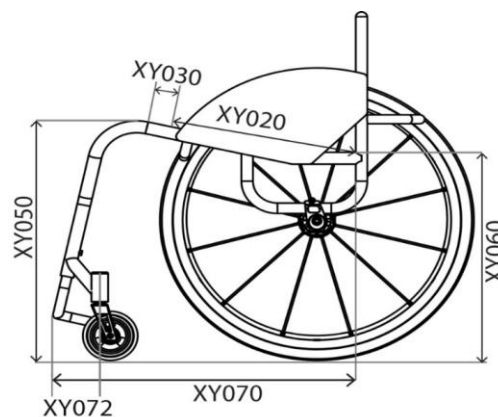
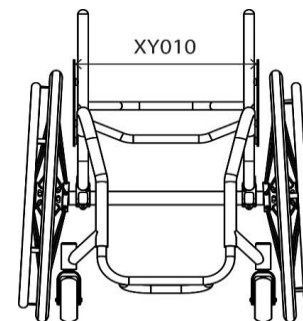
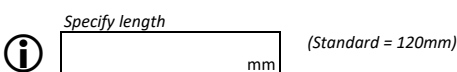

## FRONT FRAME AND FOOTREST

### Front Frame Options

XY080 Seat taper design

**i** Specify width  mm

(When combined with XY091, dimension is inbetween the centre of the main bends)

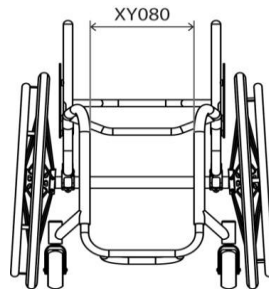

XY091 Parallel taper design

**i** Specify width  mm

(When combined with XY080, dimensions must be smaller by 20mm)

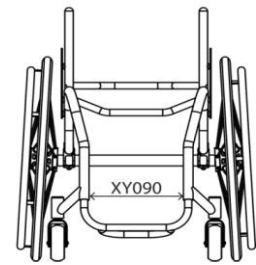

### Footrest Design (Choose One)

XY100 Round design

Castor Size	Max Height	With XB200
3"	140mm	190mm
4"	150mm	200mm
5"	160mm	210mm

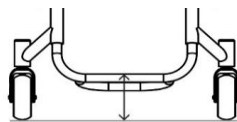

XY105 Square design

Castor Size	Max Height	With XB200
3"	135mm	185mm
4"	145mm	195mm
5"	155mm	205mm

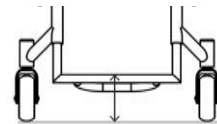

XB200 High level footrest (Only with XB010, XB080 & XB150)

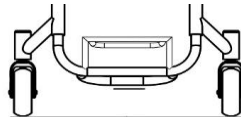

XB200 High level footrest (Only with XB010, XB080 & XB150)

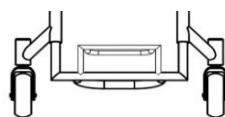

### Footrest Individual Measurements

XY115 Front footrest height

**!**  mm

XY120 Rear footrest height

**i**  mm

(Std = 20 lower than front height)

XY125 Footrest length

**i**  mm

(Std = 100mm)

(160mm and over requires heavy duty upgrade XB150)

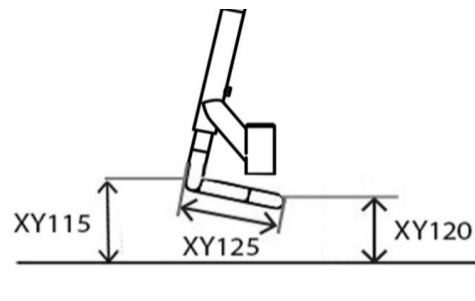

### Footrest Style (Choose One)

XB010 Tubular aluminium footrest (Height adjustable)

XB070 Angle adjustable aluminium footrest (Angle/height adjustable)

HLTXB080 Tubular footrest welded into frame (No height adjustment)

XB020 Tubular Titanium footrest (Height adjustable)

XB030 Flip up plastic footrest (Angle/height adjustable, with closed frame only)

XB150 Heavy duty tubular footrest (Height adjustable, for Freewheel use)

### Footrest Cover

XB050 Carbon fibre cover (Not with XB070 & XB030)

XB040 Plastic Cover (Not with XB070 & XB030)

XB170 Aluminium cover (Not with XB070 & XB030)

XB165 Rubber grip tape (3M Safety walk)(not with XB030)

CASTOR WHEELS, FORKS & WHEEL LOCKS	
Castor Wheels 100mm (4")	
<input type="checkbox"/> XC060	Soft roll 4"x1.3" <i>(Black)</i>
<input type="checkbox"/> XC110	Aluminium centre 4"x1" <i>(Silver hub and black urethane tyre only)</i>
<input type="checkbox"/> XC130	Aluminium centre 4"x1.4" <i>(choose colour below)</i>
<input type="checkbox"/>	<input type="checkbox"/> Silver hub & black tyre (Std) <input type="checkbox"/> Gold hub & black tyre <input type="checkbox"/> Purple hub & black tyre <input type="checkbox"/> Black hub & black tyre <input type="checkbox"/> Green hub & black tyre <input type="checkbox"/> Red hub & black tyre <input type="checkbox"/> Blue hub & black tyre
125mm (5")	
<input type="checkbox"/> XC070	Soft roll 5"x1.3" <i>(Black)</i>
<input type="checkbox"/> XC100	Pneumatic Aluminium centre 5"x1" <i>(Grey)</i>
<input type="checkbox"/> XC120	Froglegs Aluminium centre 5"x1" <i>(Silver hub and black urethane tyre only)</i>
<input type="checkbox"/> XC140	Froglegs Aluminium centre 5"x1.4" <i>(Silver hub and black urethane tyre only)</i>
150mm (6")	
<input type="checkbox"/> XC080	Soft roll 6"x1.3"
<input type="checkbox"/> XC145	Frog Legs aluminium centre 6"x1.4" <i>(Silver hub and black urethane tyre only)</i>
Castor Forks	
<input type="checkbox"/> XC192	Anti-Flutter castor fork <i>(Std when no option selected)</i>
<input type="checkbox"/> XC210	Froglegs suspension castor fork
<b>Note: Colour follows accent</b>	<input type="checkbox"/> Black <input type="checkbox"/> Silver
Castor Pin Width	
<input checked="" type="checkbox"/> XY330	Castor pin width
	<input type="text" value="mm"/>
<input type="checkbox"/>	Optimise measurements
Wheel Lock Options (choose one)	
<input type="checkbox"/> XD020	Underseat Scissor
<input type="checkbox"/> XD030	Compact scissor
<input type="checkbox"/> XD035	Compact scissor with lightweight fixing <i>(Only with fixed centre of gravity)</i>
<input type="checkbox"/> XD010	Omit wheel locks
<input type="checkbox"/> XD050	Push to lock
<input type="checkbox"/> XD046	Out Front push to lock
<input type="checkbox"/> XD085	Eagle Brakes (Indicate colour)
<input type="checkbox"/> XD086	Eagle Brakes with L/W fixing (Indicate colour) <i>(Only with fixed centre of gravity)</i>
	<input type="checkbox"/> BLACK <input type="checkbox"/> PURPLE <input type="checkbox"/> RED <input type="checkbox"/> BLUE
	<b>Black Std if no option selected</b>

## SIDEGUARDS AND ARMRESTS

Sideguard Aluminium Options		Sideguard with Fender Aluminium Options	
<input type="checkbox"/> XE030	Screw on aluminium	<input type="checkbox"/> XE040	Screw on aluminium with fender
<input type="checkbox"/> XE080	Lift out aluminium	<input type="checkbox"/> XE090	Lift out aluminium with fender
<input type="checkbox"/> HLTXE130	Fold flat aluminium	<input type="checkbox"/> HLTXE140	Fold flat aluminium with fender
<input type="checkbox"/> XE180	Flip back aluminium	<input type="checkbox"/> XE190	Flip back aluminium with fender
Carbon Fibre Options		Carbon Fibre Options	
<input type="checkbox"/> XE050	Screw on carbon fibre	<input type="checkbox"/> XE060	Screw on carbon fibre with fender
<input type="checkbox"/> XE100	Lift out carbon fibre	<input type="checkbox"/> XE110	Lift out carbon fibre with fender
<input type="checkbox"/> HLTXE150	Fold flat carbon fibre	<input type="checkbox"/> HLTXE160	Fold flat carbon fibre with fender
<input type="checkbox"/> XE200	Flip back carbon fibre	<input type="checkbox"/> XE210	Flip back carbon fibre with fender
ABS Plastic Options		Sideguard Measurements	
<input type="checkbox"/> XE070	Screw on ABS plastic	Fender Height	
<input type="checkbox"/> XE120	Lift out ABS plastic	<input type="checkbox"/> 10mm above tyre <i>(Standard)</i>	
<input type="checkbox"/> HLTXE170	Fold flat ABS plastic	<input type="checkbox"/> Individual above tyre <i>(Min = 10mm)</i>	
		<input type="checkbox"/> <input type="text" value="mm"/>	
Titanium Options		Fender position	
<input type="checkbox"/> HLTXE220	Welded with 6mm bead	<input type="checkbox"/> Centre of tyre <i>(Standard if no option selected)</i>	
		<input type="checkbox"/> Outside of tyre	
Sideguard Measurements Optimised measurements		Armrest Options	
<input type="checkbox"/> 25mm above tyre <i>(Follow tyre)</i>		<input type="checkbox"/> XF010	Lift out armrest with plastic sideguard <i>(Indicate fixed height)</i>
<input type="checkbox"/> Individual above tyre <i>(Follow tyre)</i>		<input type="checkbox"/> XF020	Lift out armrest with Aluminium sideguard <i>(Indicate fixed height)</i>
<input type="checkbox"/> Level with tyre <i>(Follow tyre)</i>		<input type="checkbox"/> <input type="text" value="mm"/>	<input type="checkbox"/> <input type="text" value="mm"/>
Individual measurements		<input type="checkbox"/> Sideguard length	<input type="checkbox"/> <input type="text" value="mm"/>
<input type="checkbox"/> Sideguard height	<input type="checkbox"/> <input type="text" value="mm"/>	<input type="checkbox"/> <input type="text" value="mm"/>	<input type="checkbox"/> <input type="text" value="mm"/>

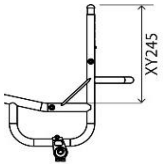
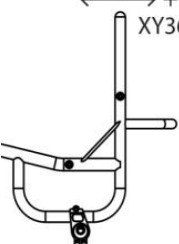
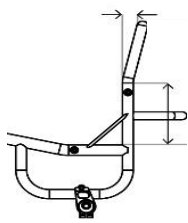
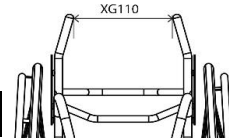
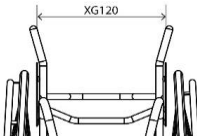
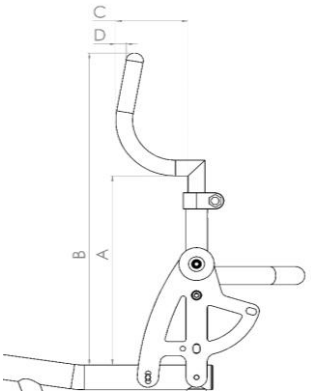
BACKREST									
Backrest Height - Fixed or Adjustable (Choose One)									
<input type="checkbox"/> XY230 Fixed height backrest Specify height <input style="width: 100px;" type="text"/> mm 	<input type="checkbox"/> XY245 Adjustable height backrest (+/25mm) Specify height <input style="width: 100px;" type="text"/> mm 								
Backrest Design									
<input type="checkbox"/> XG010 Fixed backrest (Non-folding)	<input type="checkbox"/> HLTXG020 Folding backrest with 2 position snap lock and angle adjust ( $\pm 5$ Deg)								
Ergonomic Options									
<input checked="" type="checkbox"/> XY360 Backrest angle -5   -3   0   +3   +5 Individual <input style="width: 100px;" type="text"/> Deg (Max -10/+20 Deg) 	<input type="checkbox"/> XG100 Ergonomic backrest Vertical height <input style="width: 100px;" type="text"/> mm Rearward position <input style="width: 100px;" type="text"/> mm 								
<input type="checkbox"/> XG110 Inward taper (inside of backrest posts) Specify width or per side <input style="width: 100px;" type="text"/> mm 	<input type="checkbox"/> XG120 Outward flare (inside of backrest posts) Specify width or per side <input style="width: 100px;" type="text"/> mm 								
Push handle Options									
<input type="checkbox"/> XG070 Screw in push handles (N/A with XY245) <input type="checkbox"/> XG080 Flip down push handles (N/A with XY245) <input type="checkbox"/> XG085 Flip down push handles height adjustable (N/A with XY245)	<input type="checkbox"/> XG090 Stroller push handles height adjustable Height from floor <input style="width: 100px;" type="text"/> mm <input type="checkbox"/> Optimise (1000mm from floor) <input type="checkbox"/> XG097 Integrated push handle (quickie design)								
Backrest Options									
<input type="checkbox"/> XG040 Heavy duty backrest upgrade (Recommended for hand cycling) (Not with XY245)	<input type="checkbox"/> XG130 Extra deep brace bar (Recommended for JAY backs) (Std - 90mm) Specify depth <input style="width: 100px;" type="text"/> mm								
ILSA Backrest Options									
<input type="checkbox"/> XG140 Integrated lateral support <table style="width: 100%; border: none;"> <tr> <td style="width: 50%;">A - Left <input style="width: 100px;" type="text"/> mm</td> <td style="width: 50%;">A - Right <input style="width: 100px;" type="text"/> mm</td> </tr> <tr> <td>B - Left <input style="width: 100px;" type="text"/> mm</td> <td>B - Right <input style="width: 100px;" type="text"/> mm</td> </tr> <tr> <td>C - Left <input style="width: 100px;" type="text"/> mm</td> <td>C - Right <input style="width: 100px;" type="text"/> mm</td> </tr> <tr> <td>D - Left <input style="width: 100px;" type="text"/> mm</td> <td>D - Right <input style="width: 100px;" type="text"/> mm</td> </tr> </table>	A - Left <input style="width: 100px;" type="text"/> mm	A - Right <input style="width: 100px;" type="text"/> mm	B - Left <input style="width: 100px;" type="text"/> mm	B - Right <input style="width: 100px;" type="text"/> mm	C - Left <input style="width: 100px;" type="text"/> mm	C - Right <input style="width: 100px;" type="text"/> mm	D - Left <input style="width: 100px;" type="text"/> mm	D - Right <input style="width: 100px;" type="text"/> mm	
A - Left <input style="width: 100px;" type="text"/> mm	A - Right <input style="width: 100px;" type="text"/> mm								
B - Left <input style="width: 100px;" type="text"/> mm	B - Right <input style="width: 100px;" type="text"/> mm								
C - Left <input style="width: 100px;" type="text"/> mm	C - Right <input style="width: 100px;" type="text"/> mm								
D - Left <input style="width: 100px;" type="text"/> mm	D - Right <input style="width: 100px;" type="text"/> mm								

CAMBER BAR	
Adjustable Centre of Gravity	
<input type="checkbox"/> XH110 Square back adjustable centre of gravity (25-150mm)  <input style="width: 100px; height: 20px;" type="text"/> mm  	<input type="checkbox"/> HLTXH090 V-style fixed centre of gravity (25-125mm)  <input style="width: 100px; height: 20px;" type="text"/> mm  
<input type="checkbox"/> XH120 Round back adjustable centre of gravity (60-150mm)  <input style="width: 100px; height: 20px;" type="text"/> mm  	
Specify Camber Angle	
<input checked="" type="checkbox"/> XY390 Camber angle  <input type="checkbox"/> 0 <input type="checkbox"/> 1 <input type="checkbox"/> 2 <input type="checkbox"/> 3 <input type="checkbox"/> 5	<input checked="" type="checkbox"/> XY390 Camber angle  <input type="checkbox"/> 0 <input type="checkbox"/> 1 <input type="checkbox"/> 2 <input type="checkbox"/> 3 <input type="checkbox"/> 5
Camber Bar Options	
<input type="checkbox"/> XH040 Handbike camber bar fixed  <div style="display: flex; align-items: center;"> <div style="margin-right: 10px;"></div> <div>             Camber angle (<i>Handbike camber bar</i>)  <input type="checkbox"/> 0 <input type="checkbox"/> 5           </div> </div> <div style="display: flex; align-items: center; margin-top: 10px;"> <div style="margin-right: 10px;"></div> <div>             Castor height from floor for handbike fitting              (Standard 30mm if not indicated)  <input type="checkbox"/> 30 <input type="checkbox"/> 50           </div> </div>	<input type="checkbox"/> XH040 Handbike camber bar fixed  <div style="display: flex; align-items: center;"> <div style="margin-right: 10px;"></div> <div>             Camber angle (<i>Handbike camber bar</i>)  <input type="checkbox"/> 0 <input type="checkbox"/> 5           </div> </div> <div style="display: flex; align-items: center; margin-top: 10px;"> <div style="margin-right: 10px;"></div> <div>             Castor height from floor for handbike fitting              (Standard 30mm if not indicated)  <input type="checkbox"/> 30 <input type="checkbox"/> 50           </div> </div>
<input type="checkbox"/> XH030 Frog Legs suspension camber bar	
Anti-Tip Options	
<input type="checkbox"/> XJ010 Swingaway anti tip LEFT side ( <i>Only with square back frame. Not with XH040</i> )	<input type="checkbox"/> XJ100 Single sport anti tip ( <i>centre mounted</i> )
<input type="checkbox"/> XJ020 Swingaway anti tip RIGHT side ( <i>Only with square back frame. Not with XH040</i> )	

REAR WHEELS			
Rear Wheel Size			
<input type="checkbox"/> XY420	24" Wheels	<input type="checkbox"/> XY430	25" Wheels
		<input type="checkbox"/> XY440	26" Wheels
Rear Wheel Gap			
<input checked="" type="checkbox"/> XY460	Rear wheel gap		
	<input type="checkbox"/> 15 <input type="checkbox"/> 20 <input type="checkbox"/> 25	Individual	<input type="text" value="mm"/>
Wheel Options (Choose one)			
<input type="checkbox"/> XK010	Fusion 16 spoke <i>(Silver Hub, black spokes)</i>	<input type="checkbox"/> XK320	Spinergy <b>XLX</b> 12 spoke
<input type="checkbox"/> XK050	Spinergy <b>LX</b> 12 spoke	<input type="checkbox"/> XK060	Spinergy <b>SPOX</b> 18 spoke
<input type="checkbox"/> XK150	Spinergy <b>CLX</b> 18 carbon blade spoke <b>N/A IN SILVER HUB</b>	<input type="checkbox"/> XK070	Spinergy <b>BLXL</b> 18 blade spoke <b>N/A IN SILVER HUB</b>
<input type="checkbox"/> XK155	Spinergy <b>CX6</b> carbon blade spoke <b>N/A IN SILVER HUB</b>		
<b>Spinergy Colour Options:</b>			
<input type="checkbox"/> Black spokes	<input type="checkbox"/> White spokes	<input type="checkbox"/> Yellow spokes	<input type="checkbox"/> XK180 Individual spoke design <i>(Specify colour)</i>
<input type="checkbox"/> Red spokes	<input type="checkbox"/> Blue spokes	<input type="checkbox"/> Pink spokes	Inside: _____
<input type="checkbox"/> Purple spokes	<input type="checkbox"/> Orange spokes	<input type="checkbox"/> Green spokes	Outside: _____
<b>Spinergy Anodise Options</b>			
<input type="checkbox"/> XK190	Black hub <i>(std option)</i>	<input type="checkbox"/> XK200	Silver hub <i>(n/a with BLXL/CLX)</i>
<input type="checkbox"/> XK201	Red hub/rims <i>(LX, XLX &amp; BLXL only)</i>	<input type="checkbox"/> XK205	Individual: Select colour: _____
<input type="checkbox"/> XK202	Purple hub/rims <i>(LX, XLX &amp; BLXL only)</i>	<input type="checkbox"/> XK203	Blue hub/rims <i>(LX, XLX &amp; BLXL only)</i>
<input type="checkbox"/> XK204	Gold hub/rims <i>(LX, XLX &amp; BLXL only)</i>		
Supply Without Wheels			
<input type="checkbox"/> XK040	Supply without Wheels		<input type="text" value="Wheel Type:"/> <input type="text" value="Tyre Type:"/>
Handrim Position / Options			
<input type="checkbox"/> XY480	Narrow set handrim	<input type="checkbox"/> XY485	Wide set handrim
<input type="checkbox"/> XL090	Remove excess mounting tabs <i>(recommended for small wheel gaps)</i>		
Handrim Styles			
<input type="checkbox"/> XL010	Aluminium hard anodised 6 tab	<input type="checkbox"/> XL040	Titanium 6 tab
<input type="checkbox"/> XL160	Elipse 6 tab <i>(replacement for Surge)</i>	<input type="checkbox"/> XL035	Natural Fit LT
<input type="checkbox"/> XL020	Tetra grip 6 tab	<input type="checkbox"/> XL150	Carbolife Gekko <input type="checkbox"/> Black <input type="checkbox"/> Silver
<input type="checkbox"/> XL100	Para grip 6 tab	<input type="checkbox"/> NEW	Carbolife Curve L <i>(Black)</i>
Tyre Options			
<input type="checkbox"/> XM010	Kenda <input type="checkbox"/> Grey <input type="checkbox"/> Blue <input type="checkbox"/> Red <i>(Std)</i>	<input type="checkbox"/> XM060	Schwalbe One <i>(24", 25" only)</i>
<input type="checkbox"/> XM130	Kenda black	<input type="checkbox"/> XM050	Kenda K885 mountain bike tyre <i>(24", 25" only)</i>
<input type="checkbox"/> XM020	Schwalbe Marathon Plus	<input type="checkbox"/> XM040	Shox solid airless <i>(Black)</i>
Inner Tube Valve Options			
<input type="checkbox"/> XY500	Schraeder inner tube valve <i>(Standard if no option selected)</i>	<input type="checkbox"/> XY490	Presta inner tube valve
Wheel Accessories			
<input type="checkbox"/> XK220	Titanium 130mm quick release axle pins <i>(pair)</i> <b><i>(N/A with XK010 &amp; XK070)</i></b>	<input type="checkbox"/> XK300	Offroad wheel set 22" rim with handrim, MTB tyre and axle pins <b><i>(Replaces 24" wheel with XM010)</i></b>
<input type="checkbox"/> XK240	Quad release axle nuts <i>(pair)</i>	<input type="checkbox"/> XK310	Offroad wheel set 24" rim with handrim, MTB tyre and axle pins <b><i>(Replaces 25" wheel with XM010)</i></b>

FINISH OPTIONS					
Frame & Component Finish					
<input type="checkbox"/> XN010 Powder coated frame		<input type="checkbox"/> XN150 Powder coated components <i>(Frame colour if not specified)</i>			
Frame Comp.	Gloss	Frame Comp.	Matt	Frame Comp.	Special
<input type="checkbox"/>	<input type="checkbox"/> Black gloss 103	<input type="checkbox"/>	<input type="checkbox"/> Black matt 105	<input type="checkbox"/>	<input type="checkbox"/> Chrome Mirror 300
<input type="checkbox"/>	<input type="checkbox"/> White gloss 100	<input type="checkbox"/>	<input type="checkbox"/> White matt 101	<input type="checkbox"/>	<input type="checkbox"/> Sparkle silver 170
<input type="checkbox"/>	<input type="checkbox"/> Grey gloss 132	<input type="checkbox"/>	<input type="checkbox"/> Grey matt 131	<input type="checkbox"/>	<input type="checkbox"/> Metallic black matt 104
<input type="checkbox"/>	<input type="checkbox"/> Cream gloss 135	<input type="checkbox"/>	<input type="checkbox"/> Light grey matt 133	<input type="checkbox"/>	<input type="checkbox"/> Metallic grey matt 130
<input type="checkbox"/>	<input type="checkbox"/> Red gloss 108	<input type="checkbox"/>	<input type="checkbox"/> Navy blue matt 152	<input type="checkbox"/>	<input type="checkbox"/> Black sandpaper 201
<input type="checkbox"/>	<input type="checkbox"/> Yellow gloss 120			<input type="checkbox"/>	<input type="checkbox"/> Grey sandpaper 202
<input type="checkbox"/>	<input type="checkbox"/> Forest green gloss 143			<input type="checkbox"/>	<input type="checkbox"/> White sandpaper 200
<input type="checkbox"/>	<input type="checkbox"/> Green gloss 107				
<input type="checkbox"/>	<input type="checkbox"/> Dark blue gloss 151	<input type="checkbox"/>	XN200 Individual paint colour (State Colour/RAL code)	Frame	Comp
<input type="checkbox"/>	<input type="checkbox"/> Royal blue gloss 154			<input type="checkbox"/>	<input type="checkbox"/>
<input type="checkbox"/>	<input type="checkbox"/> Blue gloss 174				
<input type="checkbox"/>	<input type="checkbox"/> Duckegg blue gloss 141				
<input type="checkbox"/>	<input type="checkbox"/> Pink gloss 188				
<input type="checkbox"/>	<input type="checkbox"/> Orange gloss 180				
<input type="checkbox"/>	<input type="checkbox"/> Purple gloss 157				
<input type="checkbox"/>	HLTXN030 Bead blast frame <i>(All parts black unless XN160 chosen)</i>	<input type="checkbox"/>	XN165 Bead blast components		
<input type="checkbox"/>	HLTXN050 Polished frame <i>(All parts black unless XN160 chosen)</i>	<input type="checkbox"/>	XN170 Polished components		
Accent Colour					
<b>Note:</b> Accent colour includes, forks, castor caps and axle clamps.					
<input type="checkbox"/>	Black accent	<input type="checkbox"/>	Silver accent	<input type="checkbox"/>	XN250 Individual Accent Colour
<input type="checkbox"/>	Red accent	<input type="checkbox"/>	Blue accent		
<input type="checkbox"/>	Purple accent				
UPHOLSTERY					
Seat Upholstery					
<input type="checkbox"/>	XP040 Seat sling adjustable tension with straps	<input type="checkbox"/>	XR050 Carbon fibre seat plate		
Backrest Upholstery					
<input type="checkbox"/>	XP050 Airtech backrest strap adjustable	<input type="checkbox"/>	XP070 Backrest upgrade to leather corners <i>(Black)</i>		
Backrest Stitching Colour					
<input type="checkbox"/>	Silver	<input type="checkbox"/>	Black	<input type="checkbox"/>	Blue
<input type="checkbox"/>	Red	<input type="checkbox"/>	Orange	<input type="checkbox"/>	Purple
				<input type="checkbox"/>	Individual:
RGK Logo Colour					
<input type="checkbox"/>	White (Std)	<input type="checkbox"/>	Green	<input type="checkbox"/>	Blue
<input type="checkbox"/>	Red	<input type="checkbox"/>	Orange	<input type="checkbox"/>	Purple
				<input type="checkbox"/>	Individual:
Model Logo Colour					
<input type="checkbox"/>	White (Std)	<input type="checkbox"/>	Green	<input type="checkbox"/>	Blue
<input type="checkbox"/>	Red	<input type="checkbox"/>	Orange	<input type="checkbox"/>	Purple
				<input type="checkbox"/>	Individual:
Backrest Accessories					
<input type="checkbox"/>	XP110 Backrest with zip pocket	<input type="checkbox"/>	XP170 Individual backrest embroidery <i>PLEASE COMPLETE PAGE 11</i>		

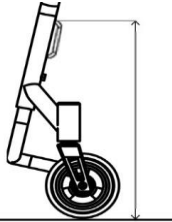
CUSHION	
Cushion foam options	
<input type="checkbox"/> XP080	Cushion foam <i>(select density and size below)</i>
<input type="checkbox"/> Soft (CMS040)	<input type="checkbox"/> Medium (CMS050)
<input type="checkbox"/> 50mm	<input type="checkbox"/> 75mm <input type="checkbox"/> 100mm
Cushion cover options	
<input type="checkbox"/> XP085	Nylon cushion cover <i>(Black)</i>
<input type="checkbox"/> XP090	Air Lite cushion cover <i>(Black)</i>
<input type="checkbox"/> XP100	Leather cushion cover <i>(Black)</i>
Jay Products - PLEASE PROVIDE JAY ORDER FORM	
<input type="checkbox"/> JAY Cushion <i>(Price dependant on size / option)</i>	<input type="checkbox"/> <i>Jay Order form attached</i>
<input type="checkbox"/> JAY Backrest <i>(Price dependant on size / option)</i>	<input type="checkbox"/> <i>Jay Order form attached</i>
<input type="checkbox"/> JAY Whitmyer Headrest <i>(Price dependant on size / option)</i>	<input type="checkbox"/> <i>Jay Order form attached</i>
FRAME OPTIONS	
<input type="checkbox"/> XR060	Welded calf strap mounting loops <i>(To locate calf strap on front frame)</i>
	Specify height from floor <input style="width: 100px; height: 20px;" type="text"/>
<input type="checkbox"/>	<i>Optimise measurements</i>
	
ACCESSORIES	
<input type="checkbox"/> XR080	Frontwheel assembly <i>(Only with Tubular style footrest)</i>
<input type="checkbox"/> XP120	Frame protectors Neoprene zip fasten with TIGA logo <i>(Back)</i>
<input type="checkbox"/> XP420	Frame protectors Nylon velcro fasten <i>(Black)</i>
<input type="checkbox"/> XR010	Seat pouch velcro attach <i>(Back)</i>
<input type="checkbox"/> XR200	Rucksack with RGK logo <i>(Back)</i>
<input type="checkbox"/> XR020	Underseat large storage bag <i>(Back)</i>
<input checked="" type="checkbox"/> XA020	Tool kit
<input checked="" type="checkbox"/> XS060	Calf strap

## DONATE / PART EXCHANGE

Donate your old chair for up to off this order\*

\*Participating RGK resellers only. Any donation chair must include a functional frame and wheels. RGK will replace the upholstery and arrange delivery to a worthy cause.

Chair Make/Model: \_\_\_\_\_

Chair Serial/Ref No: \_\_\_\_\_

Agreed Value: \_\_\_\_\_

Part Exchange your old chair for up to off this order\*

\*Participating RGK resellers only. Any Part Exchange chair must be less than 5 years old and include a functional frame, componentry and wheels.

Chair Make/Model: \_\_\_\_\_

Chair Serial/Ref No: \_\_\_\_\_

Agreed Value: \_\_\_\_\_

## ADDITIONAL NOTES

### INDIVIDUAL BACKREST EMBROIDERY

PLEASE PROVIDE JPEG IMAGE AT TIME OF ORDER AND NOTE POSITION BELOW



### BRACE BAR

### SPEC NOTES: